



**KEEP IN VEHICLE**  
READ OPERATING INSTRUCTIONS  
INSIDE BEFORE OPERATING PTO

# GM6B SERIES PTO INSTALLATION

**FOR GENERAL MOTORS 3600 CAB CHASSIS WITH  
ALLISON 1000 SERIES AUTOMATIC TRANSMISSION**

*Use this manual in conjunction with PTO Manual IN84-03 enclosed with PTO.*

(Contact a Muncie customer service representative for PTO application on other GM chassis with Allison automatic transmissions.)



# PTO INSTALLATION ALLISON AUTOMATIC

1. READ WARNING ON INSIDE OF FRONT COVER OF THE PTO INSTALLATION AND OWNER'S MANUAL INCLUDED WITH THIS PTO.
2. Read PTO installation Manual IN84-03 included with PTO before getting started. Section one of the IN84-03 applies to all PTO installations including this PTO.
3. Allow Engine and exhaust system to cool before beginning installation.
4. Remove exhaust on gas engine vehicles
5. Remove full floor board heat shield from under right side of cab
6. Install partial heat shield. Using the factory installation attachment points of the heat shield you just removed.

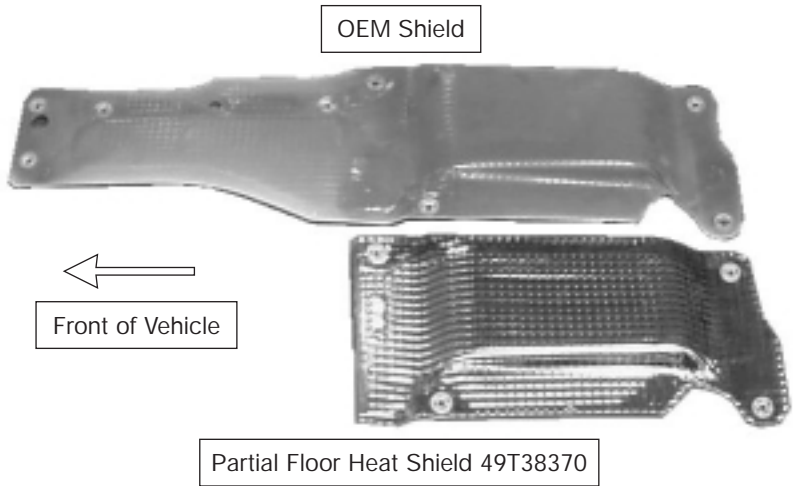

7. Remove the OEM heat shield attached to the lower portion of the transmission and save for re-installation later.

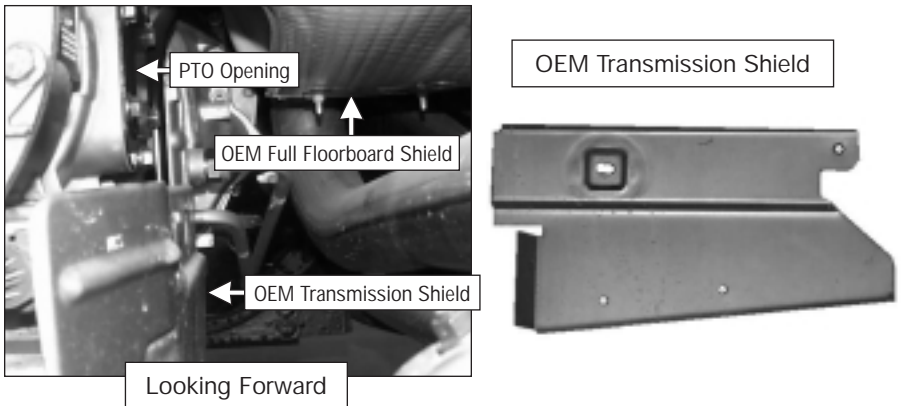



Muncie Heat Shield Installed

Looking Rearward

8. Caution: Transmission fluid may be HOT. Remove PTO cover and clean PTO mounting surface, taking care not to let contamination fall into PTO opening. Shop rag can be used for additional protection. Remove shop rag when finished.
9. Install PTO mounting studs provided matching the 10mm thread to the transmission.

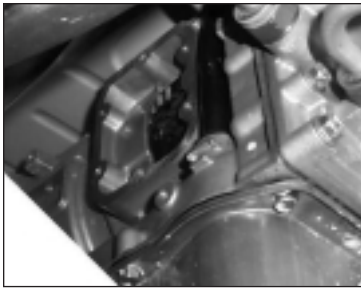

12 Point Capscrew  
19T35778  
30-35 lbs.ft.

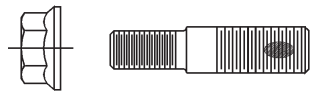
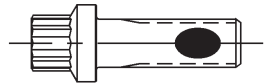

Whiz-Lock Nut 22T37607  
17-20 lbs.ft.  
Step Stud 20T37952

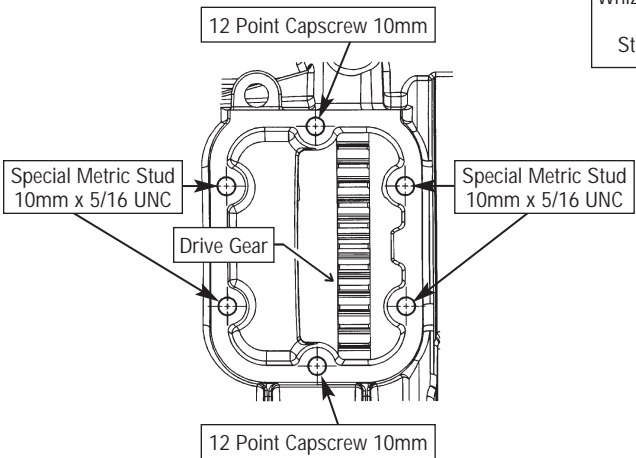

10. Install GM6B PTO using Gasket/Shim and additional mounting capscrews provided.
11. On the left side opening remove the two PTO cover capscrews shown and install solenoid bracket, provided.

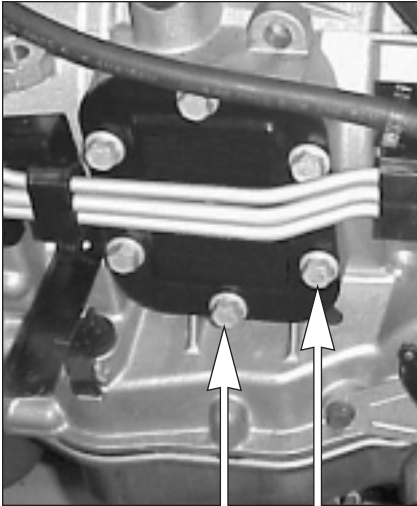

Remove These Capscrews and Re-use to Mount Bracket

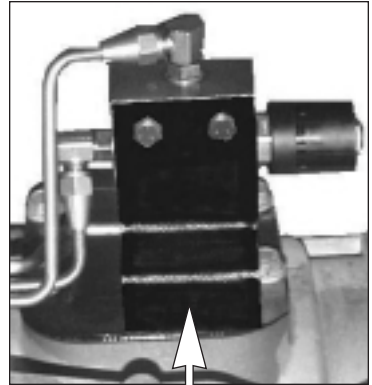

Solenoid Mounting Bracket  
49T38282

49T38282

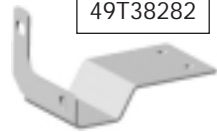

12. Install fittings into activation solenoid manifold.

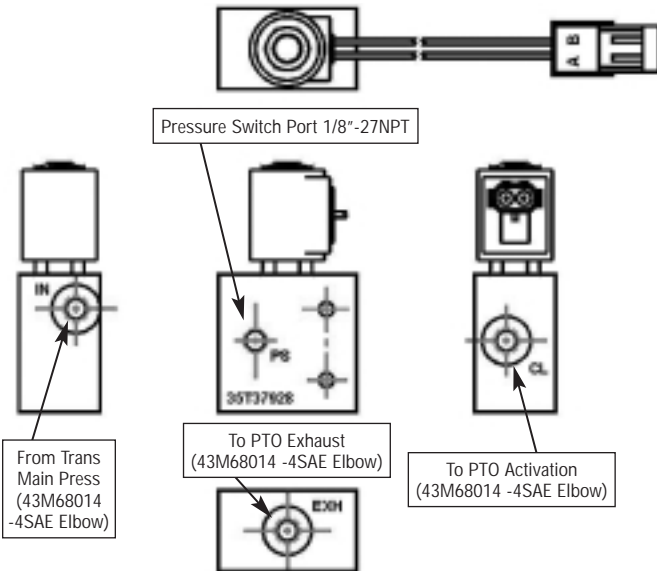

13. Mount solenoid to bracket (49T38282) using 1/4"-20 x 2.0" bolts (19T36623) and nuts (22MX2520), install pressure switch into manifold.

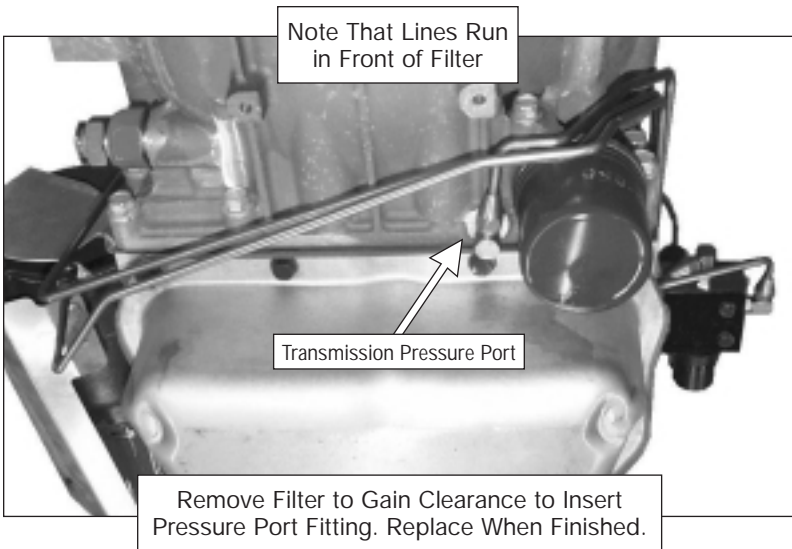
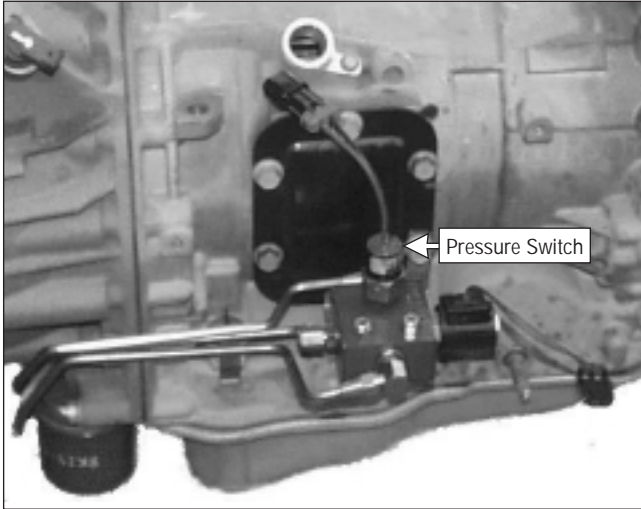

14. Remove the plug from the activation port in the bottom of the transmission and install fitting (43M68014 -4SAE 90° Str. Thd to JIC).

**15.** Install fitting into appropriate ports on the PTO as shown.



**16.** Select the appropriate 1/4" steel lines as shown.

**17.** Install the steel lines to the activation port, exhaust port, and main pressure port.

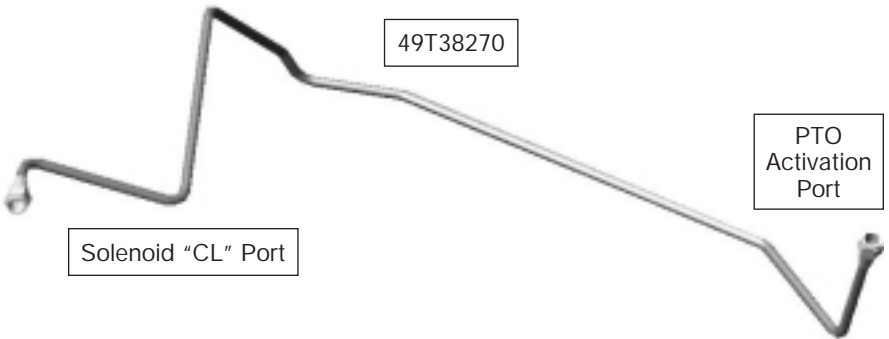

PTO Engage line  
(Connect to CL port on solenoid and cylinder port on PTO end cover)

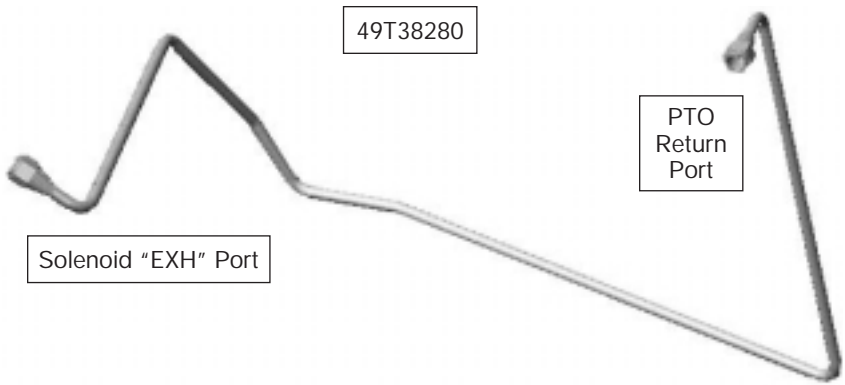

PTO Exhaust line (Connect to EXH port on solenoid and to return port on side of PTO housing.)

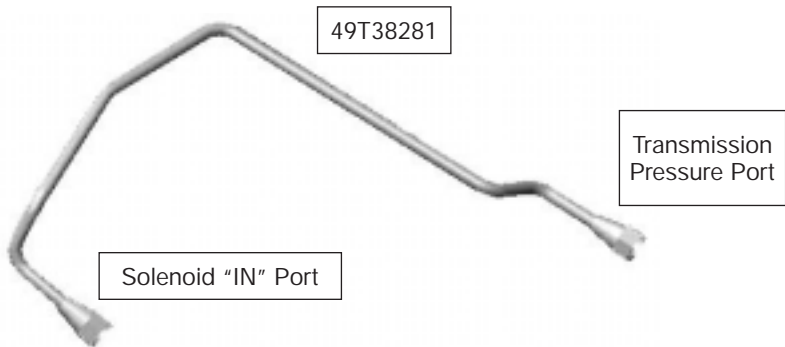

PTO - Transmission- Pressure line (Connect to Transmission Main pressure port and to IN port on solenoid block.)

18. Remove the cap plug from the PTO output shaft.
19. Install the pump port fittings in to the PF series pump. The inside pump mounting capscrew may need to be place in pump mounting flange prior to installing the suction fitting. (Pump Inlet = 43T38323 -16SAE Elbow. Pump Pressure = 43T38392 -10SAE Elbow) The automatic transmission requires a Right Hand rotation pump and uses the side ports.
20. Install the heat shield bracket to the pump by removing the rear pump cap-screw shown at shield bracket below. Torque capscrew to 55 lbs.ft.
21. Install the PF series hydraulic pump so that pump offset is up.

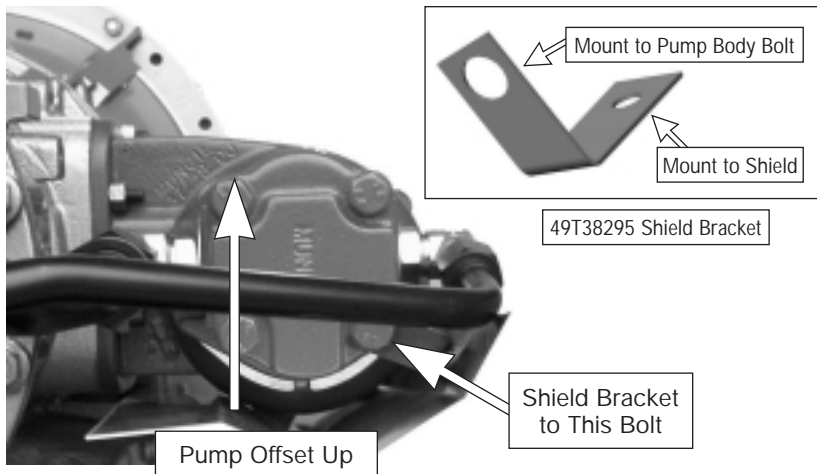

22. This places the inlet port next to the transmission side for the Automatic transmission.
23. Install the hydraulic pump line support bracket on the top/back of the transmission using two transmission bolts.

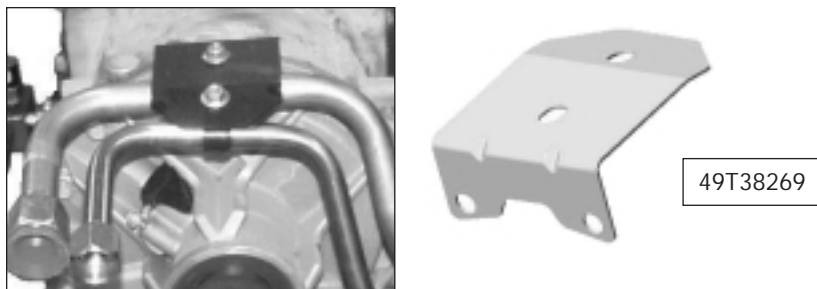

24. Install and connect the appropriate steel hydraulic lines to the pump and attach them to the support bracket installed at the back of the PTO using the supplied clamps and 3/8"-24 x .5" bolts.

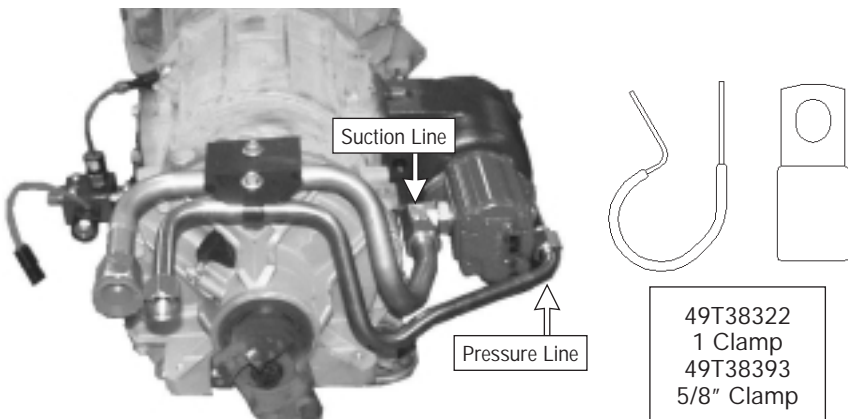



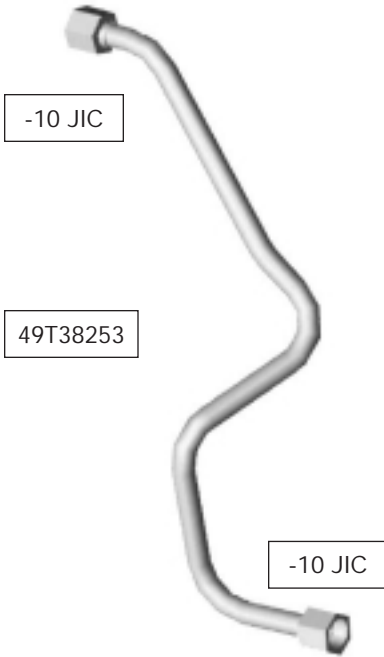

Pump Pressure Line

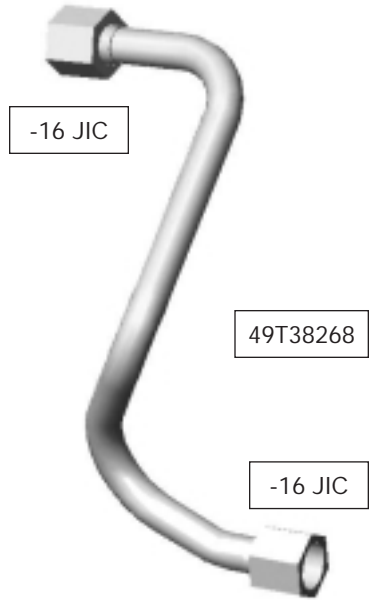

Pump Suction Line

25. Install the GM activation switch into the dash by following the instruction page included.



# POWER TAKE OFF SWITCH INSTALLATION INSTRUCTIONS

30T38371 Power take off switch  
34T38335 Wiring harness

## SWITCH INSTALLATION INSTRUCTIONS

1. Apply parking brake to prevent the vehicle from moving.
2. If equipped with an automatic transmission, move the shift lever all the way down to the last gear.
3. Tilt the steering wheel to the full down position.
4. Pull gently on the corners of the instrument panel trim plate trim plate to remove it. (Figure A)
5. Find the switch accessory housing to the right of the heating and air controls. (Figure B)
6. Remove switch accessory housing and the lower left switch accessory cover from the housing. The switch accessory housing is snapped into the instrument panel retainer.
7. Install the Power Take-Off switch in the lower left cavity of switch housing. From the front of the housing, push until it clicks into place.
8. Locate the power take-off switch harness and connect it to the Power Take-Off switch. (Figure C)
9. Replace the switch accessory housing into the instrument panel.
10. Attach bezel to the instrument panel assembly by aligning the guide pins and pushing gently on the bezel until it is in place.
11. Ensure that all instrument panel bezel retaining clips are in place and tilt the steering wheel to the normal drive position.
12. Move the shift lever to the park position.

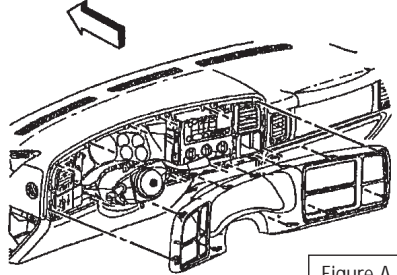

Figure A

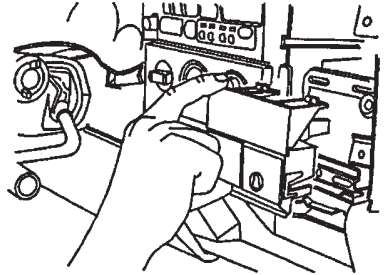

Figure B

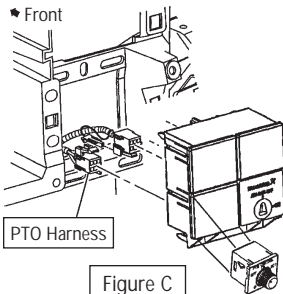
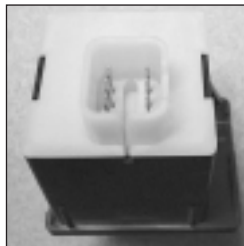
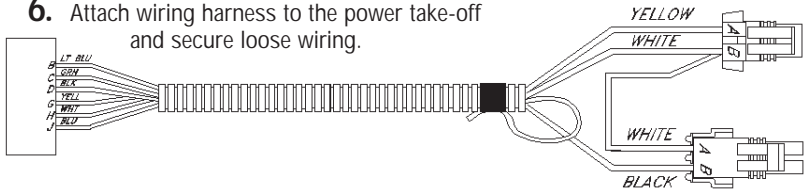

Figure C



# HARNESS INSTALLATION INSTRUCTIONS

1. The supplied harness 34T38335 is assembled according to the specification chart Figure D. The blunt cut wires are for remote functions and are not used for PTO activation.
2. Raise vehicle with jack or hoist to access Power Take-Off and transmission.
3. Locate the power take-off harness secured to the transmission by the fuel feed and evaporative emission and return hose bracket. (Figure E)
4. Remove the protective plug from the connector.
5. Connect the power take-off harness to the supplied wiring harness.
6. Attach wiring harness to the power take-off and secure loose wiring.



PIN	Circuit	Color	Description	Function
B	494A	Light blue	Power Take-Off switch – output – fault	Used for engine disable switch output
C	488A	Light green	Power Take-Off switch – output – enable	Remote set speed switch input
D	550A	Black	Ground	Ground
G	2522A	Yellow	Power Take-Off switch – signal status	Used for Power Take-Off engaged feedback*
H	2561A	White	Power Take-Off replay – output – N.O. contact	Used to supply switched power to Power Take-Off
J	84A	Dark Blue	Cruise Control switch – signal – set/coast	Remote set speed switch output

\* Required to turn power take off switch request LED from flashing to steady. Also used to disable OBDII diagnostics when the power take off is operating.

Figure D

26. Locate the 10 pin connector attached to upper left hand side of the transmission. The plug is inserted into a cap for storage.

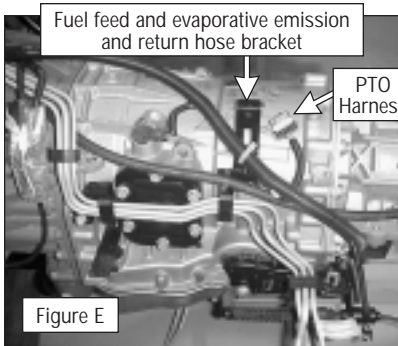
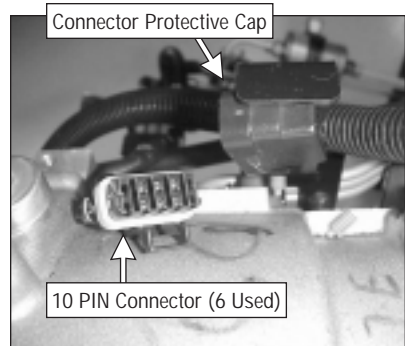
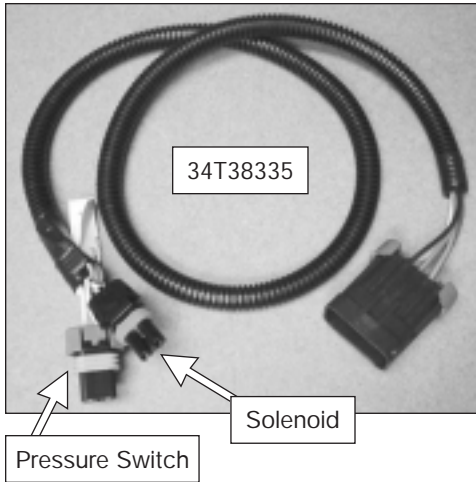

Figure E



27. Plug the 10 pin connector on the wire harness supplied, into the transmission connector.
28. The other end of the harness has two plugs. Match the plug to the pressure switch and the plug to the activation solenoid and connect together.



29. Check the mounting fasteners of the PTO and the Pump and make sure they are tight.
30. Install the heat shield to the front of the PTO using hexhead capscrews provided.

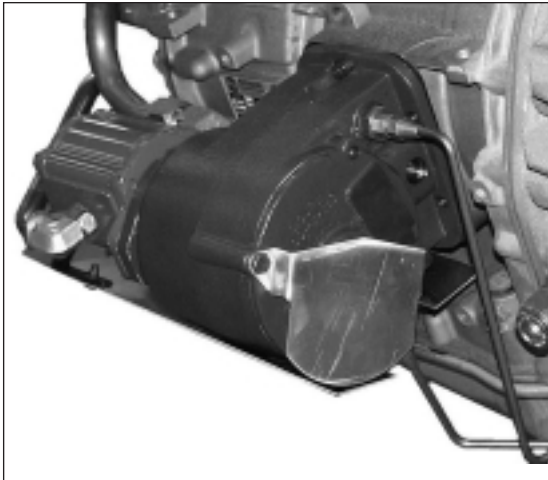

PTO Heat Shield  
49T38294

31. Slide the U-Nut 22T38325 onto the 1/4" hole and mount the shield 49T38501 at the slot with the 1/4"-20 x .5" capscrew (19T37440). Mount the shield to the PTO housing using the 1/4"-20 x .5" capscrews to the 49T38295 shield bracket.



PTO Heat Shield 49T38501

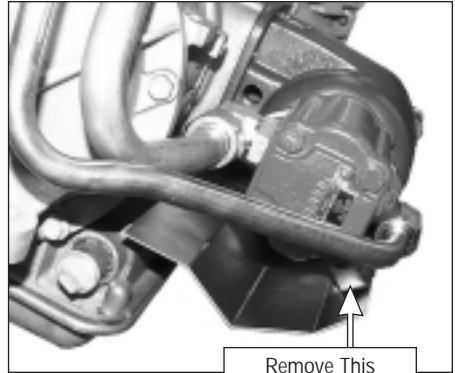

Remove This Capscrew and Install Shield Bracket

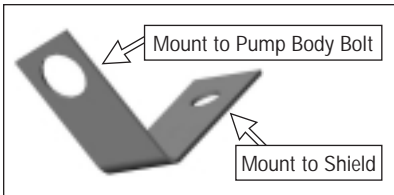

49T38295 Shield Bracket

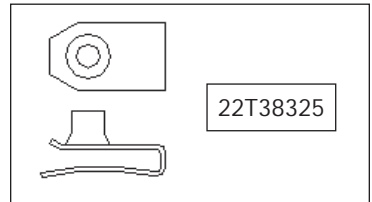

22T38325

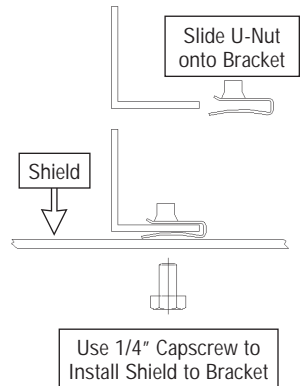
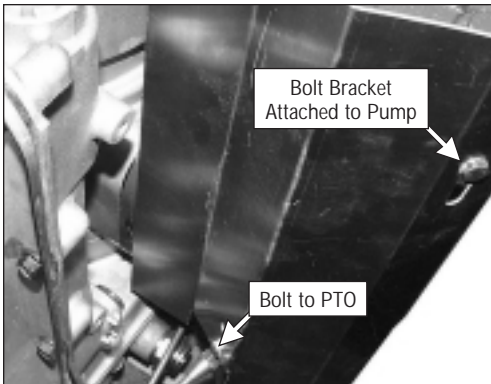

32. Re-install the transmission heat shield removed in step 7.
33. **IMPORTANT:** Before activating the PTO the remainder of the hydraulic system must be connected, including hydraulic reservoir, control valves, and hydraulic oil. **DO NOT** operate PTO until the hydraulic system is completed and hydraulic system is properly filled with oil. Complete installation by placing warning labels as indicated on decal borders. Placement examples are shown in the PTO Owner's Manual IN84-03.

34. After installation of the hydraulic system and filling the reservoir with the proper hydraulic fluid operate the system and listen for noise. It is a common occurrence that this PTO system will produce a rattling noise. Most of this noise can be attributed to the total drivetrain torsional vibration which is transmitted through the components and amplified by the heat shield system installed around and to the PTO. When the hydraulic system is energized and placed under a load this noise should greatly diminish. If this is the case then the noise should not be detrimental to the application. If not then double check that you have used the proper mounting gasket (13M13541 .030") to mount the PTO. Then, remove PTO for inspection of transmission and PTO.
35. To operate the PTO be sure that the engine is at idle speed. Turn the rotary switch to the "On" position.
36. Enclosed are operating instructions for the switch and throttle advance.
37. The vehicle is supplied from the Dealer with the preset throttle option. If you desire the variable throttle option the vehicle control module will need to be changed by the Dealer.

## PTO OPERATION

### Recommended procedure for engaging a PTO (Auto Transmission):

1. For stationary use Shift transmission into Park (P).
2. Rotate PTO control switch to the on position. The PTO will engage while vehicle is stationary or mobile, if the engage criterion is met.
3. If the engine speed is below the PTO engage speed limit, the PTO will start. The blinking LED on the PTO control switch indicates PTO engage is requested. When the PTO engages the LED on the PTO control switch changes from blinking to steady state.



### Using PTO speed control in Preset Mode (Factory Default Setting):

1. PTO engaged.
2. Select PARK (P) or NEUTRAL (N) Range. Recommend applying Park Brake if Neutral is selected. Torque Converter Clutch (TCC) lockup is not available in Neutral. TCC lockup is available in Park if above 1100 rpm.
3. Foot off brake pedal (and off clutch for manual transmission).
4. Select desired engine speed for PTO operation. Please read the following Preset Mode section regarding operation.

### Preset Mode:

PTO speed control mode used for stationary applications (PTO will remain engaged while mobile in the preset mode however PTO set and resume speed controls will be inoperative). This mode provides a default standby speed of 800 or 850 rpm (depending on the engine/transmission combination) and two default PTO control speeds: PTO Set Speed of 1250 rpm, and PTO Resume Speed of 1700 rpm. Please note that the standby speed (800/850 rpm) is not to be used as a PTO control speed. Vehicles not equipped with cruise control will not have the resume speed capability. The graphics on page 15 depict how to achieve the desired speeds with the set and resume switches.



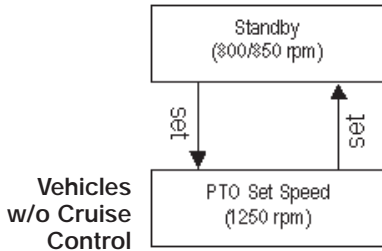

### Variable Mode:

PTO speed control mode used for both stationary and mobile applications. This mode allows PTO to be controlled in a fashion similar to which a cruise control controls vehicle speed. The operator can set to a RPM (between 800 and 2200) with the set switch on the cruise stalk or with the set position on the PTO rotary switch. The operator is then able to “tap up” in 100 rpm increments with the resume switch on the cruise stalk or “tap down” with either set switch (on the cruise stalk or the PTO rotary switch). Vehicles not equipped with cruise control will not have the “tap up” capability.

### Cruise Equipped Vehicles

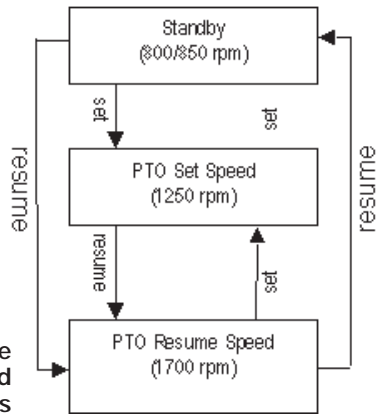

### Using PTO speed control in Variable Mode (while Mobile):

1. PTO engaged.
2. Vehicle speed greater than 5 mph.
3. Foot off brake pedal (and off clutch for manual transmission).
4. Obtain desired engine speed (with foot pedal) and select set on the PTO rotary switch or the cruise stalk.

### Using PTO speed control in Variable Mode (while Stationary):

1. PTO engaged.
2. Vehicle speed less than 5 mph.
3. Foot off brake pedal (and off clutch for manual transmission).
4. Obtain desired engine speed (with foot pedal) and select set on the PTO rotary switch or the cruise stalk.

**Note:** All engine speed values listed above are factory default values. With the exception of the TCC lockup speed (1100 rpm) and the “tap” increment (100 rpm) all of these values are programmable and can be adjusted by your GM dealer or body upfitter with a Tech-2 service tool. If your vehicle PTO software settings do not match the settings shown here then they may have already been altered by the body upfitter in order to satisfy the requirements of the installed PTO system and body equipment.

## 48TK4415 INSTALLATION KIT-TUBING/SHIELD USED ON GM6B PTO

QTY	PART NUMBER	Part Name Description
1	50M20025	Box
1	49T38501	Shield
1	49T38282	Bracket Solenoid
1	49T38269	Bracket
1	49T38268	Tubing Suction
1	49T38253	Tubing Discharge
1	49T38270	Tubing Engage
1	49T38281	Tubing Pressure
1	49T38280	Tubing Vent
1	49T38370	Shield
1	48TK4059	Kit (Content Shown Below)

## 48TK4059 INSTALLATION KIT USED ON GM6B PTO

QTY	PART NUMBER	Part Name Description
1	52MK1009	Gasket Kit
1	20TK4058	Stud Kit
1	35T37928	Solenoid Valve
1	30T37954	Pressure Switch—12v
1	36MK3841	Label Packet-English
1	22T38325	Nut-U
1	49T38322	Clamp
1	49T38393	Clamp
1	49T38295	Bracket
4	43M68014	Adapter-Hydraulic 90
1	43T38323	Adapter-Hydraulic 90
1	43T38392	Adapter-Hydraulic 90
2	43T36431	Adapter-Hydraulic Straight
2	19T35708	Bolt
2	22T21723	Nut
3	19T37440	Bolt
2	19T36623	Bolt
2	22MX2520	Nut
1	30T38371	Switch
1	34T38335	Wire Harness
1	49T38294	Shield



**Muncie®**  
**Power**  
**Products**

Muncie Power Products, Inc. General Offices and Distribution Center  
P.O. Box 548 • Muncie, IN 47308-0548 • (765) 284-7721 • FAX (765) 284-6991  
E-mail [info@munciepower.com](mailto:info@munciepower.com) • Web site <http://www.munciepower.com>  
Drive Products, Inc., Toronto, Exclusive Agents for Canada