

KEEP IN VEHICLE
READ OPERATING INSTRUCTIONS
INSIDE BEFORE OPERATING PTO

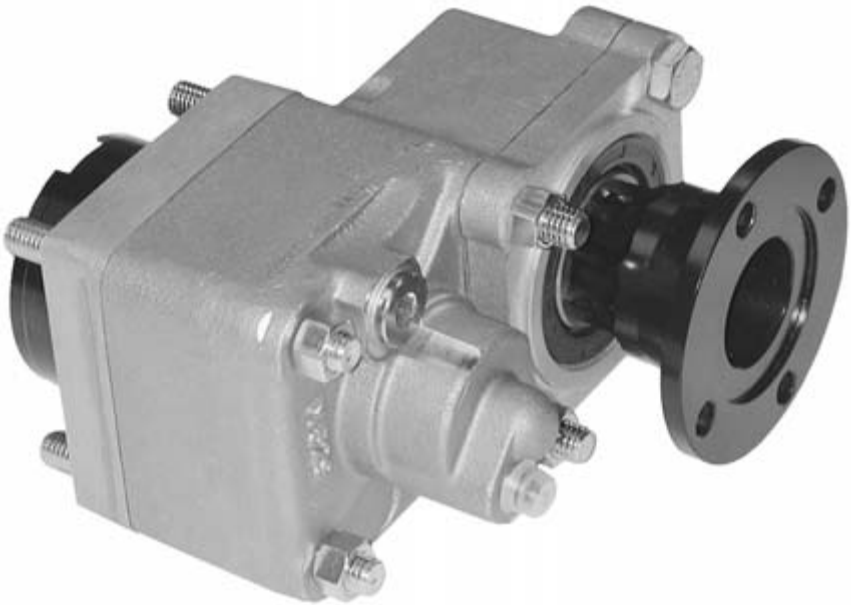







PTO INSTALLATION and OWNER'S MANUAL

**RS4S-P82Z1 SERIES PTOS AND
RS4S-P86Z* SERIES PTOS FOR
ZF/MERITOR FREEDOMLINE
SERIES TRANSMISSIONS**



**Muncie®
Power
Products**

WARNING

-  **DO NOT ATTEMPT TO INSTALL OR SERVICE ANY POWER TAKE-OFF WITH THE TRUCK ENGINE RUNNING. PUT THE IGNITION KEYS IN YOUR POCKET BEFORE GETTING UNDER THE TRUCK.**
-  **DO NOT ALLOW TRUCK ENGINE TO BE STARTED WHILE WORKERS ARE UNDER THE TRUCK.**
-  **IMMOBILIZE TRUCK WHEELS WITH SUITABLE CHOCKS BEFORE WORKING UNDER TRUCK.**
-  **BE SURE TO BLOCK ANY RAISED BODY OR MECHANISM BEFORE WORKING ON OR UNDER THE EQUIPMENT.**
-  **INSTALLED POWER TAKE-OFFS MUST NEVER BE SHIFTED IN OR OUT OF GEAR BY ANY MEANS EXCEPT BY THE CONTROLS IN THE CAB OF THE TRUCK.**
-  **STAY CLEAR OF SPINNING DRIVESHAFTS TO AVOID BECOMING ENTANGLED AND INJURED.**
-  **IT SHALL BE THE RESPONSIBILITY OF THE INSTALLER OF A MUNCIE POWER TAKE-OFF TO DECIDE WHETHER TO INSTALL GUARDS IN THE PTO AND/OR DRIVELINE AREA BECAUSE OF POTENTIAL EXPOSURE TO DANGER.**
-  **THIS IS BECAUSE MOST MUNCIE PTOS ARE INSTALLED BY EQUIPMENT DISTRIBUTORS OR MANUFACTURERS AND THEREFORE, THE RESPONSIBILITY OF THE INSTALLATION IS BEYOND THE CONTROL OF MUNCIE POWER PRODUCTS.**

The PTO is supplied with a packet containing warning labels. If you did not receive any, or if you need extra, you may order them, no charge, by phone or mail. They are available through your nearest Muncie distributor or at the number and address below:

**Muncie Power Products, Inc.
P.O. Box 548, Muncie, IN 47308-0548**

**1-800-FOR-PTOS (367-7867)
info@munciepower.com**

The ZF/Meritor Freedomline transmission offers a rear mount PTO output location. You will find this at the right rear of the main transmission housing. There is only this one opening available on this series of transmissions. The transmission electronics must also be programmed for PTO operation. If you are unsure whether or not your transmission is equipped for PTO operation, then contact your Vehicle dealer and they will contact ZF/Meritor for verification.

The Freedomline transmission is available in different forward speeds. Identification is found on the ID tag. This will determine the output shaft speed of the PTO being mounted. Make sure that you have reviewed this information with a qualified Muncie representative. The transmission output driveline is available with different driveline yoke series. The Spicer SPL 175 and SPL 250 Series interferes with all PTOs and the Rockwell Series RPL25 interferes with the RS4S-P86Z* Series PTO. Before driving the vehicle, make sure that the main driveshaft does not come in contact with the PTO or any of its components.

Read all of the directions listed below before installation. If you have any questions, call Muncie Power Products, Inc. for assistance at 1-800-367-7867 and ask for the Customer Service Department.

SECTION 1: PTO INSTALLATION INSTRUCTIONS

- There is a packet with the PTO which contains 4 WARNING LABELS. Before adhering the labels, make sure the surfaces are free of dirt and grease. Place the labels supplied as follows:

There are two (2) labels which measure approximately 4" x 8" which are to be placed on the outside of the vehicle frame rail, making them easy to be seen by anyone who might go under the truck or near the PTO. One label is to be placed on each side of the vehicle. **Fig 1**

Should the body installed on the chassis cover the frame rail, place the label on the body in a position easily visible by anyone who might go under the vehicle or near the PTO. **Do not paint over labels.**

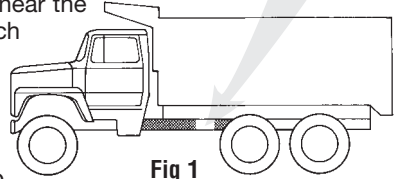
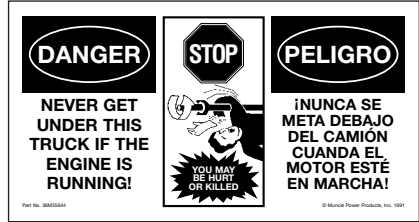

Fig 1

There are two (2) 4" X 8" labels supplied and one is to be placed on each side of the vehicle.

- The 2" x 3" PTO Equipped Caution Label is to be placed within the cab of the vehicle and in easy view of the vehicle operator. It should be located near the PTO control, when the control is installed in the vehicle dash. **Fig 2.** This label directs the operator to read the PTO operating instructions on the "Visor Label". The Visor Label 4" x 6 1/2" is to be placed on the visor on the operator's side of the vehicle. **Fig 2**

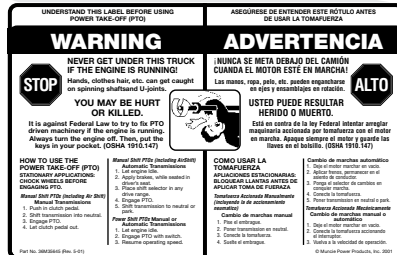
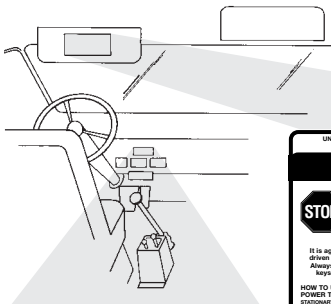
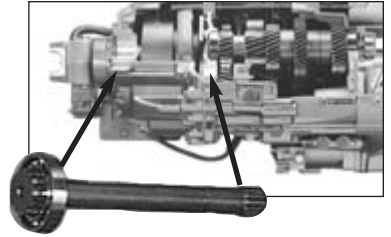
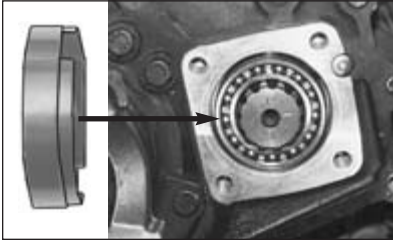

Fig 2

- CAUTION:** Transmission fluid may be hot. Remove the cover plate from the right rear countershaft and clean the mounting surface.



- 4.** Insert the intermediate shaft into the transmission countershaft. This should slide easily into the transmission and does not require using force.



- 5.** Install bearing ring, narrow edge first, by tapping it in evenly around the bearing. Tap the ring just below the surface.

- 6.** Use the PTO adapter pilot to press the bearing ring into place by using a wood block and tapping it into place. Remove the adapter plate and set aside.

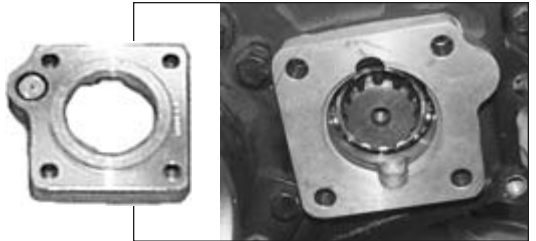

- 7.** Remove the lube plug in the back of the transmission pad.

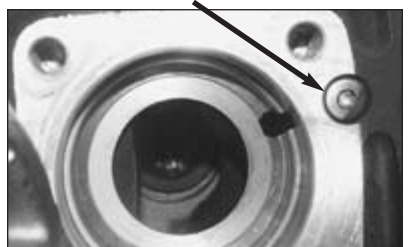

- 8.** Place the supplied gasket eliminator on the mounting face.



- 9.** Place the o'ring in position in the lubrication port on the adapter and then place the adapter on pad and align mounting holes.

- 10.** Fill the PTO with appropriate transmission fluid prior to installing.



- 11.** Using the gasket between the PTO and the adapter, install the PTO, making sure that it is positioned as shown. Use the enclosed studs by inserting short threaded length into the transmission housing. Use of Loctite 242 or 262 is recommended. Tip: The two shorter studs are used near the output shaft of the transmission, insert these into the PTO as you mount the PTO and screw them into the transmission case with the PTO held in position.

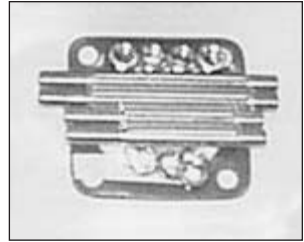

PTO output shaft mounts in the 3:00 position only, as shown here. SAE "B" output ("K" option) must also mount in this orientation. Observe potential obstructions to the rear of the PTO before installing drivelines or hydraulic pumps. Hydraulic pumps mounted to the "K" option are limited to 25 lbs. total weight.



- 12.** Use lock washers and nut and torque to 45 ft.lbs.
13. Make the air activation installation using the diagram included.

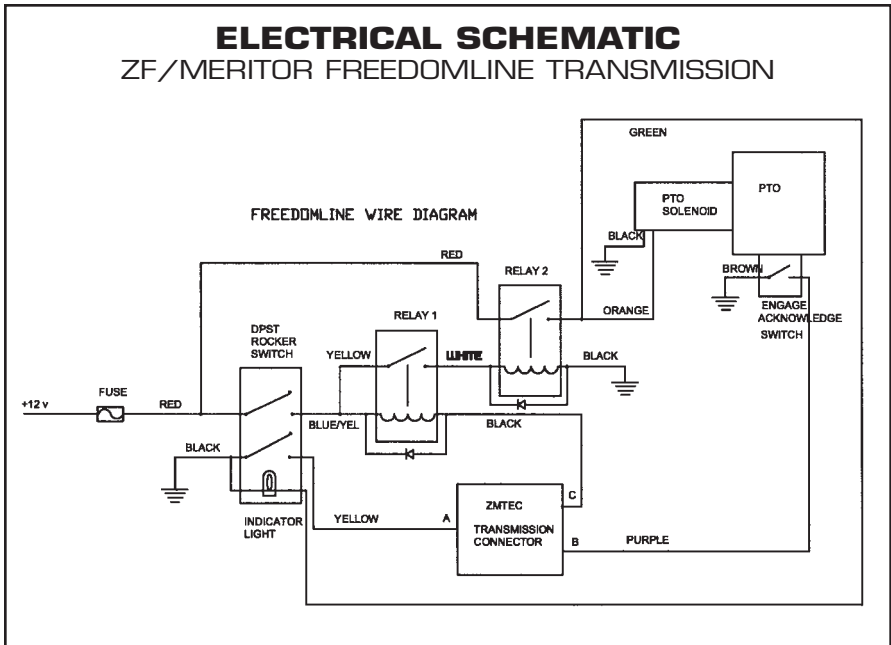

INSTALLATION WIRING DIAGRAM FOR RS4S-P82Z1-E1CX OR RS4S-P86Z*-Z1CX ELECTRIC/AIR SHIFT SYSTEM

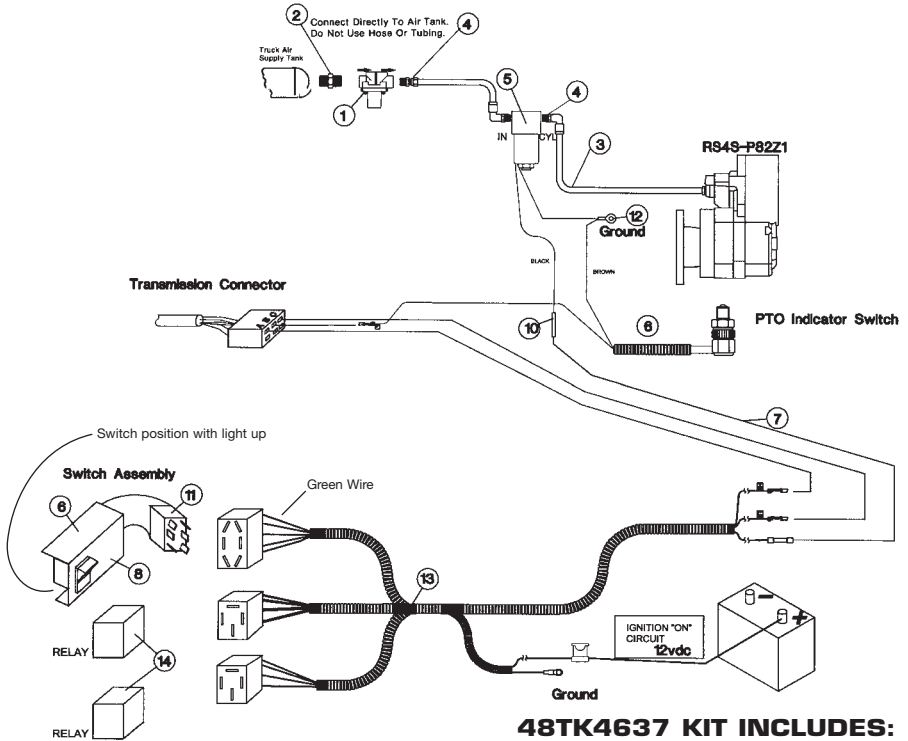

48TK4637 KIT INCLUDES:

QTY	PART NO.	DESCRIPTION
1	36MK3841	Safety Label Kit
1	13M51717	Liquid Gasket
1	48TK4636	Activation Kit
1	48TK4635	Electric Wiring Kit

ELECTRIC/AIR ACTIVATION KIT 48TK4636

ELECTRICAL WIRING KIT 48TK4635

ITEM	QTY	PART NUMBER	DESCRIPTION
1	1	31M15759	Pressure Protection Valve
2	1	44MB2164	Nipple
3	1	45M44430	Airline
4	3	44MB6844PTC	Fitting
5	1	35M30692	12VDC Solenoid, Air
N.S.	1	48TA3953	Mounting Kit, Solenoid
6	1	34T38909	Wire Harness, Indicator Swt
7	15	37M18000	Wire
8	1	36T36271	Face Plate
9	1	36MA1005	Bracket
10	3	34M18002	Butt Splice
11	1	30T38858	Rocker Switch
12	1	34M18009	Ring Terminal
13	1	34T38868	Wire Harness
14	2	37M52285	Relay

- 14.** Make the electrical connections.

The PTO is supplied with a wire harness, 34T38909 for the indicator switch.

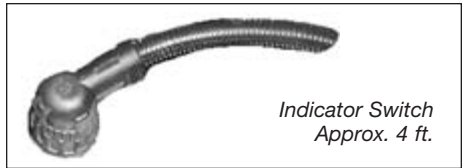

- 15.** This kit contains all of the components for the electrical installation. Make appropriate switch installation into vehicle dash or bracket provided. Faceplate can be used as a template for dash cut-out.

It is recommended that there be a PTO indicator light installed in clear view of the vehicle operator while seated in the driver's seat. Obtain additional indicator light as needed.

Install the supplied rocker switch and relays into their appropriate sockets. Rocker switch mounts to socket with green wire in "up" position and indicator light in "up" position.



- 16.** Locate the Metri-Pack terminals attached to the wires shown in the diagram. Route the wire leads marked "A" and "C" to the driver's side of the transmission.

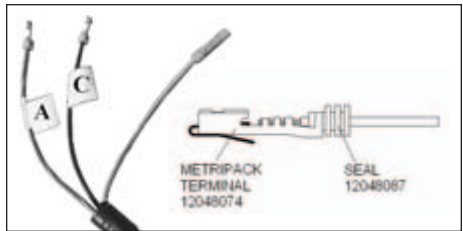

- 17.** Locate the 6 terminal transmission plug. Remove the blank plug from the connector.



- 18.** Remove the gray locking clip from blank plug. Remove the seals from cavity "A", "B", and "C".

- 19.** Push the terminal on the wire from switch harness labeled "A" into cavity "A" and terminal "C" into cavity "C".

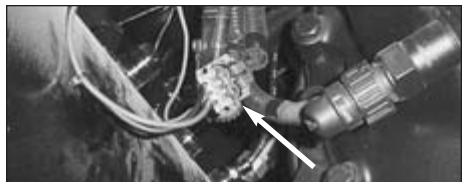

- 20.** Connect the wire harness to the PTO indicator switch by aligning the circular connector and turning it clockwise to make the connection. Route the wire away from rotating components and heat sources and secure with cable ties.



- 21.** Connect one end of the switch signal (ring terminal) to ground and the Metri Pack terminal to the “B” cavity on the transmission plug. Replace the gray locking clip on the plug. Re-install the connector to transmission making sure that it is pushed completely together until it clicks.



- 22.** Install the driven component, then the driveline.



23. DRIVELINE PHASING

If your system utilizes a driveline between the PTO and another device and if you have noise in your system that was not there before, the angularity or phasing of your driveline may be the cause. Check driveline angularity and reduce total angularity per recommendation on chart and be sure the PTO shaft is parallel within 1.5° to the pump shaft (or driven unit). Drivelines must be in phase, that is, the yoke ears on the PTO and pump shafts must be in alignment, as illustrated below.

Max. Speed (RPM)	Max. TJA “A”
3500*	5°
3000*	5°
2500	7°
2000	8°
1500	11°
1000	12°

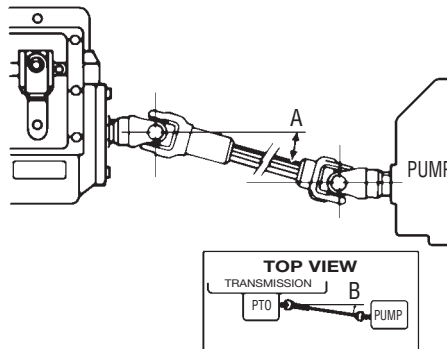

* For speeds over 2500 RPM contact Muncie for Approval.

For installations with angles in the top and side views use this formula to compute the true joint angle (TJA):

$$TJA = \sqrt{A^2 + B^2}$$

PTO WITH DIRECT COUPLE HYDRAULIC PUMP INSTALLATION

Before bolting the pump to the PTO, place non-seizing compound or grease on the PTO shaft and pump shaft. All Muncie direct mount PTOs are supplied with the appropriate grease. Reusing an existing pump will require inspection of the pump splines. Clean any old grease from pump prior to installation. The Optional hydraulic pump mount is limited to hydraulic pumps weighing less than 30 lbs. total system weight. (for DIN 5462 mount) or 25 lbs. (for SAE “B” mount). The DIN 5462 (Option “I”) is the preferred hydraulic mount. *Weight includes fittings, oil, and unsupported hose sections.

This requirement does not take into account the system duty cycles, vehicle vibrations, application, terrain, and other external influences. We recommend that direct mounted components of any size or weight be driveline driven when these conditions are extreme or unknown.

This recommendation is based upon our experiences to date. Any failure as a result of damage caused by unsupported weight attached to the PTO will affect any warranty considerations. Most Muncie direct mount flanges offer multiple mounting bolt holes which allow the flange to be rotated to multiple locations on the PTO for improved port location or clearance. Be sure to torque the cap screw to 25 ft.lb., and it is advisable to use a thread locker to secure the cap screws (Loctite 241 or NyLoc or equivalent).

(Do not force spline couplings together)

24. Check the transmission fluid level before operating system and fill to proper level with approved fluid.
25. Install PTO decals as described in Steps 1 & 2, if you haven't already done so.

SECTION 2: OPERATORS INSTRUCTIONS

Basic System Description -

FreedomLine™ transmissions are designed to operate in automatic or manual mode through a two-pedal driving system (brake and accelerator). Clutch actuation and transmission shifts are pneumatically powered and electronically controlled using a TCU. PTO installers must ensure that PTOs are integrated in a manner that permits proper transmission control of PTO engagement and PTO disengagement.

FreedomLine™ transmissions are designed to communicate transmission-PTO activity to drivers via the transmission display in the vehicle. The following diagram shows an overview of the intended transmission-PTO interfaces.

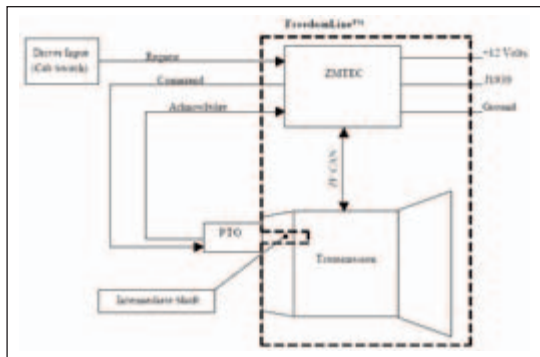

FreedomLine™ Transmission Software - FreedomLine™ transmissions must be programmed with ZMTEC software that allows PTO operation. Contact ZF Meritor LLC with questions concerning your ZMTEC software.

Default Parameters - FreedomLine™ transmissions are designed to operate PTOs with a maximum engine speed of 1800 revolutions per minute. The default configuration for PTO. If desired, the default configurations may be altered using VEPS. ‘Stationary’ operation and ‘non-stationary’ operation are defined in the following subsections.

Stationary - When FreedomLine™ transmissions are configured for stationary PTO operation, PTOs must only be operated when the transmission is in neutral with no vehicle movement. Shifting is not permitted.

Non-Stationary - Reference the following table for the gears that could be selected when FreedomLine™ transmissions are configured for non-stationary PTO operation. PTOs must be physically engaged before selecting a forward or reverse starting gear. Gear shifting with PTOs engaged is permissible only at standstill.

NOTE: FreedomLine™ transmissions are designed to seek neutral when neutral button is pressed.

Transmission Model	PTO Use Restricted to Transmission Starting Gear
12 Direct Drive	Neutral, 1st, 3rd, Reverse Low
12 Overdrive	Neutral, 2nd, Reverse High
16 Overdrive	Neutral, 2nd, 4th, Reverse High

PTO ACTIVATION AND DEACTIVATION

Manually Engaged PTOs - FreedomLine™ transmissions must control PTO engagement; therefore, PTO installers or users should confirm, that manually engaged PTOs are not installed separate of the Freedomline system.

PTO Activation Sequence



Request PTO – The Muncie PTO includes a rocker switch, for PTO operators to send an active low request signal to FreedomLine™ transmissions via the FreedomLine™ transmission wiring harness. NOTE: A transition from high voltage to low voltage is required for FreedomLine™ transmissions to recognize PTO requests. If the PTO request is already at low voltage (i.e. turned on), then FreedomLine™ transmissions are designed to function in normal drive mode until a transition to low voltage is encountered (i.e. switched off, then on).

FreedomLine™ Transmission Response

Conditions for PTO Engagement - The following conditions are typical for PTO. PTO installers & PTO users should confirm any such conditions, and further requirements, with PTO manufacturers.

- Vehicle engine must be running,
- FreedomLine™ transmissions must be in neutral,
- There must be no active shift commands present,
- The engine must be running with a valid engine speed signal available,
- The output speed must be less than the standstill threshold (i.e. complete stop),
- The accelerator pedal must be in the idle position (i.e. foot off accelerator),
- The PTO request must be active.
- There must be no active PTO faults present.

Fault Check - FreedomLine™ transmissions are designed to perform a series of checks to verify the conditions. If those conditions are not met, FreedomLine™ transmissions are designed either to ignore the request, continuing in normal drive mode, or to set an active PTO fault. PTO fault codes include Acknowledge Fault, Engagement Fault, and Disengagement Fault.

NOTE: PTO operation is possible with certain FreedomLine™ transmission faults present.

Active PTO Faults Detected - If an active FreedomLine™ transmission fault or PTO fault is detected at any time during PTO engagement, the PTO command from FreedomLine™ transmissions is designed to automatically discontinue. Normal driving conditions prevail.

Active PTO Faults Absent - If FreedomLine™ transmissions detect no active fault codes, and no conditions that prevent PTO engagement, they are designed to automatically shift gear positions, if necessary, and automatically command PTOs.

Engagement Command - After the conditions are met, FreedomLine™ transmissions are designed to automatically send a load reduction request to the engine. To complete this load reduction, the clutch is designed to open and the FreedomLine™ transmission brake reduces the input speed to the transmission. FreedomLine™ transmissions are designed to send an engagement command to PTOs shortly before standstill of the FreedomLine™ transmission counter-shafts. The FreedomLine™ transmission brake is designed to disengage and the clutch to partly close, allowing dog clutch PTOs to engage without ‘tooth-on-tooth’ interference.

NOTE: FreedomLine™ transmissions are designed to attempt to engage PTOs regardless of the force supplied to PTO solenoids. Pneumatic or hydraulic solenoids that lose pressure, for example, may grind as FreedomLine™ transmissions attempt to engage PTOs.

Physical Engagement - If no conditions that prevent PTO engagement are present, then physical engagement of PTOs will occur. After physical engagement of PTOs, FreedomLine™ transmissions must be operated as outlined.

Acknowledgement - Active low feedback from PTOs to FreedomLine™ transmissions is required and must acknowledge PTO engagement. When PTOs are successfully engaged, as evidenced by the feedback from PTOs, then a properly integrated FreedomLine™ transmission display is designed to indicate that one or more PTOs are active. FreedomLine™ transmissions are designed to set a PTO fault and recognize an error when feedback from PTOs is delayed beyond a monitoring time of approximately 1.5 seconds. Properly integrated FreedomLine™ transmissions are designed to automatically discontinue PTO engagement and to resume normal drive conditions.

PTO Deactivation Sequence



PTO Request Termination - The active low PTO request must typically be terminated to begin the PTO disengagement process. (PTO switch turned “Off”)

FreedomLine™ Transmission Response - FreedomLine™ transmissions are designed to disengage PTOs whenever the PTO request is terminated. PTO operators may terminate the request at standstill or while driving, both with the gears engaged and in neutral.

Discontinue Engagement Command - After FreedomLine™ transmissions verify the termination of PTO request, properly integrated FreedomLine™ transmissions are designed to request an engine load reduction. The clutch is designed to open and complete the load reduction before the PTO engagement command is terminated.

Physical Disengagement - If no conditions that prevent PTO disengagement are present (i.e. torque bound, etc.), PTO disengagement will occur per the PTO manufacturer’s design and the shift interlock will typically terminate automatically. If PTOs fail to disengage, a PTO fault will typically occur and FreedomLine™ transmissions are designed to maintain current PTO conditions.

Acknowledgement - When PTOs are successfully disengaged, as evidenced by the active low PTO feedback, a properly integrated FreedomLine™ transmission display is designed to no longer indicate that PTOs are active, and normal drive conditions resume. FreedomLine™ transmissions are designed to set a PTO fault and recognize an error when feedback from PTOs continues beyond a monitoring time of approximately 1.5 seconds. Properly integrated FreedomLine™ transmissions are designed to ignore the disengage command and remain in the current PTO state.

Ignition Off - If the ignition is turned off during stationary PTO operation, properly integrated FreedomLine™ transmissions are designed to recognize an active PTO fault and automatically discontinue PTO engagement. If, at any time, a PTO fault registers, FreedomLine™ transmissions are designed to automatically disengage PTOs. Under conditions that prevent PTO disengagement (i.e. torque bound), FreedomLine™ transmissions are designed to default to stationary PTO operation when the transmission is turned back on.

POWER TAKE-OFF WARRANTY

The Muncie Power Take-Off is warranted to be free of defects in material or workmanship and to meet Muncie's standard written specifications at the time of sale. Muncie's obligation and liability under this warranty is expressly limited to repairing or replacing, at Muncie's option, within one year after date of original installation any defective part or parts or any product not meeting the specifications.

THIS WARRANTY IS IN LIEU OF ALL OTHER WARRANTIES, EXPRESSED OR IMPLIED. MUNCIE MAKES NO WARRANTY OF MERCHANTABILITY OR OF FITNESS FOR ANY PARTICULAR PURPOSE. MUNCIE'S OBLIGATION UNDER THIS WARRANTY SHALL NOT INCLUDE ANY TRANSPORTATION CHARGES OR COSTS OF INSTALLATION OR ANY LIABILITY FOR DIRECT, INDIRECT SPECIAL, INCIDENTAL, OR CONSEQUENTIAL DAMAGES OR DELAY. THE REMEDIES SET FORTH HEREIN ARE EXCLUSIVE, AND MUNCIE'S LIABILITY WITH RESPECT TO ANY CONTRACT OR SALE OR ANYTHING DONE IN CONNECTION THEREWITH, WHETHER IN CONTRACT, IN TORT, UNDER ANY WARRANTY, OR OTHERWISE, SHALL NOT, EXCEPT AS EXPRESSLY PROVIDED HEREIN, EXCEED THE PRICE OF THE PRODUCT OR PART ON WHICH SUCH LIABILITY IS BASED.

If requested by Muncie, products or parts for which a warranty claim is made are to be returned transportation prepaid to a Muncie Service Center. Any installation or use not in accordance with catalogue or package instructions, other improper use, operation beyond capacity, substitution of parts not approved by Muncie, use with equipment other than the equipment on which the Power Take-Off is first installed, or alteration or repair made to the Power Take-Off other than at a Muncie Service Center shall void this warranty. No employee or representative of Muncie is authorized to change this warranty in any way or to grant any other warranty.



**Muncie[®]
Power
Products**

Muncie Power Products, Inc.

Member of the Interpump Hydraulics Group

General Offices and Distribution Center

P.O. Box 548 • Muncie, IN 47308-0548 • (765) 284-7721 • FAX (765) 284-6991

E-mail info@munciepower.com • Web site <http://www.munciepower.com>

Drive Products, Exclusive Agents for Canada, ISO Certified by an Accredited Registrar

