

**Brought to you by Pro Gear &  
Transmission.**

**For parts or service call:**

**877-776-4600  
407-872-1901**



**[www.globaldifferentialsupply.com](http://www.globaldifferentialsupply.com)**

**906 W. Gore St. Orlando, FL 32805  
[parts@eprogear.com](mailto:parts@eprogear.com)**

# Foreword

This manual contains information concerning the safe operation of your vehicle. It is extremely important that this information is read and understood before the vehicle is operated. This manual also contains a considerable amount of information concerning the vehicle, such as vehicle identification, Preventive Maintenance recommendations and a log for your service records. Please keep this in the vehicle at all times. Information from other component manufacturers is supplied in separate manuals in the Owner's Package.

**NOTE!** It is important that this manual stays with the vehicle when it is sold. Important safety information must be passed on to the new customer. The service information contained in this manual gives the owner important information about maintaining the vehicle but is not intended as a substitute for the Preventive Maintenance Service Manual and must not be regarded as such.

The National Highway Traffic Safety Administration (NHTSA) and Volvo Trucks North America, Inc. should be informed immediately if you believe that the vehicle has a defect that could cause a crash, injury or death.

Contact NHTSA by calling the Auto Safety Hotline at 1 (800) 424-9393 (or 366-0123 in the Washington, DC area) or by writing to: NHTSA, U.S. Department of Transportation, Washington, DC 20590.

**Volvo Trucks North America, Inc.**  
Greensboro, NC USA

**Order number: PV776-20 169629**

© 2002 Volvo Trucks North America, Inc., Greensboro, NC USA

All rights reserved. No part of this publication may be reproduced, stored in retrieval system, or transmitted in any forms by any means, electronic, mechanical, photocopying, recording or otherwise, without the prior written permission of Volvo Trucks North America, Inc..

---

# Contents

<b>General Information</b> .....	1
Introduction .....	1
EPA Emissions Performance Warranty .....	2
Noise Emissions .....	8
Noise Control System, Operator Inspection and Maintenance Requirements .....	11
Exhaust System .....	12
Air Intake/ Air Induction System .....	13
Cooling System .....	14
Sound Shielding and Insulation Devices .....	15
Noise Control Log .....	16
<b>Heating and Air Conditioning</b> .....	17
General .....	17
Climate Unit Main Control Panel .....	19
Automatic Temperature Control (ATC) Overview .....	26
Cab Ventilation .....	29
Cab Air Filter .....	30
<b>Brakes</b> .....	31
Parking Brake Alarm .....	31
Audible Warnings: .....	31
Ignition mode Warning .....	31
Running mode Warning .....	32
Alarm Warning .....	32
<b>Power Steering</b> .....	33
Adjustable Steering Column (option) .....	33

---

# Warning Label Information

## IMPORTANT

**Before driving this vehicle, be certain that you have read and that you fully understand each and every step of the driving and handling information in this Operator's Manual. Be certain that you fully understand and follow all safety warnings.**

IT IS IMPORTANT THAT THE FOLLOWING INFORMATION CONCERNING LABELS BE READ, UNDERSTOOD AND ALWAYS FOLLOWED.

The following types of labels are used throughout this manual:

**NOTE!** A note defines an operating procedure, practice, condition, etc., which is essential to the proper operation of the vehicle.



### CAUTION

A caution label directs the operator's attention to unsafe practices where personal injury is not likely but property damage could occur. The caution label is an **black** type on a **white** background with a **black** border.



### WARNING

A warning label directs the operator's attention to unsafe practices which could result in personal injury or severe damage to the vehicle. The warning label is an **black** type on a **gray** background with a **black** border.



### DANGER

A danger label directs the operator's attention to unsafe practices which could result in serious personal injury or death. The caution label is an **white** type on a **black** background with a **black** border.

## Introduction

This publication is a supplement to two Operator Manuals: The VN Operator's Manual, Group 04, PV776-TSP20 154796, published 4, 2001. and The VHD Operator's Manual, Group 04, PV776-TSP20 139484, published 8, 2000.

This supplement covers the following important additions:

- EPA Emission Performance Warranty
- Heating and Air Conditioning
- Parking Brake Alarm
- Adjustable Steering Column

## 2 General Information

---

### EPA Emissions Performance Warranty

#### **YOUR WARRANTY RIGHTS AND OBLIGATIONS**

The U.S. Environmental Protection Agency (EPA) and Volvo Trucks North America, Inc. (VTNA) are pleased to explain the emissions performance warranty on your vehicle. In compliance with section 207(b) of the Clean Air Act, VTNA must warrant the emission control system on your vehicle for the periods of time listed listed below, provided there has been no abuse, neglect or improper maintenance of your vehicle.

For instructions on proper maintenance, including time and/or mileage intervals at which such maintenance is to be performed, see your "Operator's Manual-Volvo VHD Maintenance and Engine."

Your emission control system may include parts such as carburetor or fuel injection system and engine computer. Also included may be hoses, belts, connectors or other emission-related assemblies.

Refer to the Warranty Certificate for complete coverage details.

Federal warranty provisions apply to all vehicles sold in all U.S. states and territories regardless of whether a state has enacted state warranty provisions that differ from the federal provisions.

Where a warrantable condition exists, VTNA will repair your vehicle at no cost to you (including diagnosis, parts and labor) any emission control device or system which causes a vehicle to fail an EPA-approved emission short test during its useful life, if you have maintained and operated the vehicle in accordance with the written instructions of VTNA.

If a facility at which the vehicle is initially presented for repair is unable for any reason to honor the claim, then, unless you waive in writing, the repair facility must forward the claim to VTNA warranty Administration, (336) 393-2000.

#### **MANUFACTURER'S WARRANTY COVERAGE**

This warranty is applicable for a period of five years, 100,000 miles or 3,000 hours of operation, whichever first occurs. If an emission-related part of your vehicle is defective, the part will be repaired or replaced by VTNA.

This is your emission control system DEFECTS WARRANTY.

### OWNER'S WARRANTY RESPONSIBILITIES

As the vehicle owner, you are responsible for the performance of the required maintenance listed in your owner's manual. Volvo Truck North America, Inc (VTNA) recommends that you retain all receipts covering maintenance on your truck, but VTNA cannot deny warranty solely for the lack of receipts or for your failure to ensure the performance of all scheduled maintenance.

You are responsible for presenting your vehicle to a VTNA dealer as soon as a problem exists. The warranty repairs should be completed in a reasonable amount of time, not to exceed 30 days. Claim procedures are outlined in the "Volvo Service Operations Manual."

As the vehicle owner, you should also be aware that VTNA may deny you warranty coverage if your vehicle or a part has failed due to abuse, neglect, improper maintenance or unapproved modifications.

If you have any questions regarding your warranty rights and responsibilities, you should contact VTNA Warranty Administration, (336) 393-2000.

## 4 General Information

---

### EMISSION CONTROL SYSTEM WARRANTY

Volvo Trucks North America, Inc. WARRANTS TO THE ORIGINAL OWNER, AND EACH SUBSEQUENT OWNER, OF A NEW TRUCK POWERED BY A VOLVO DIESEL ENGINE THAT THE EMISSION CONTROL SYSTEM OF YOUR TRUCK:

- 1 Is designed, built and equipped to conform at the time of sale to all regulations of the U.S. Environmental Protection Agency, applicable at the time of the manufacture; and
- 2 Is free from defects in material and workmanship which will cause the emission control components not to function as designed for a period of use of 5 years or 100,000 miles or 3,000 hours of engine operation, whichever comes first.

The 5 years/100,000 miles/3,000 hour warranty period shall begin on the date the vehicle is first delivered to the first retail purchaser or if the vehicle is placed in service as a demonstrator company vehicle prior to the sale at retail, on the date the vehicle is the first placed in service.

The emission control system of your new Volvo engine was designed, built and tested using genuine Volvo parts, and the engine is certified as being in conformity with federal emission control regulations. Accordingly, it is recommended that any replacement parts used for maintenance, replacement or repair be Volvo parts.

The owner may elect to have maintenance, replacement or repair of the emission control components and systems performed by any vehicle repair establishment or individual and may elect to use parts other than Volvo parts for such maintenance, replacement or repair without invalidating this warranty; the cost of such services or parts, however, will not be covered under the warranty except in an emergency situation. A part not being available or a repair not being completed within 30 days also constitutes an emergency.

Use of replacement parts which are not of equivalent quality may impair the effectiveness of emission control systems. If other than Volvo parts are used for maintenance, owner should obtain assurances that such parts are warranted by their manufacturer to be equivalent to genuine Volvo parts. However, the use of other than Volvo replacement parts does not invalidate the warranty on other components, unless such parts cause damage to warranted parts.

Repair and service covered by the warranty will be performed by an authorized VTNA dealer at his place of business with no charge for parts or labor (including diagnosis). The dealer uses Volvo parts for the emission control system, that required replacement and is covered by the warranty and if found defective.

In case of an emergency, where an authorized VTNA dealer is not available, repairs may be performed at any available service establishment or by the owner, using any equivalent replacement parts and VTNA will reimburse the owner for such repairs (including diagnosis) not to exceed VTNA's suggested retail price for the warranted parts and the labor rate appropriate for the geographical area and the tasks performed.

Replaced parts and paid invoices must be presented to a VTNA dealer for reimbursement.



The emissions control parts covered by this Emission Control System Warranty are listed under "What Is Covered by the Emissions Warranty." You are responsible for the performance of all required maintenance on your new Volvo engine, including maintenance or repairs needed due to severe operating conditions. VTNA will not deny a warranty claim solely because you have no record of maintenance. However, VTNA may deny a warranty claim if your failure to perform required maintenance resulted in the failure of a warranted part. Receipts covering the performance of regular maintenance should be retained in the event questions arise concerning maintenance. The receipts should be transferred to each subsequent owner of the vehicle with the emission warranted engine.

If the warranty claim is denied, VTNA shall provide a written basis for denial within 30 days or a shorter time if required by local, state or federal law. Failure to provide written basis for denial within 30 days or shorter time limit required by state, local or federal law or for reasons not attributable to the vehicle owner or events beyond the control of VTNA shall result in VTNA being responsible for repairing the vehicle free of charge to the vehicle owner.

### **CUSTOMER ASSISTANCE**

Volvo Trucks North America, Inc. wishes to help assure that the Emission Control System Warranty is properly administered. In the event that you do not receive the warranty service to which you believe you are entitled under the Emission Control System Warranty, you should contact Volvo Trucks North America, Inc. Warranty Administration, (336) 393-2000. The address and telephone number of each Regional Office is in your vehicle owner's manual. If you need additional assistance or information concerning the Emission Control System Warranty, contact: Volvo Trucks North America, Inc., Warranty Administration, (336) 393-2000.

You can obtain further warranty information or report violations of the terms of Emissions Performance Warranty by contacting the Manager, Certification and Compliance Division (6405J), Warranty Claims, Environmental Protection Agency, Ariel Rios Building, 1200 Pennsylvania Ave. N.W., Washington, D.C. 20460.

## 6 General Information

---

### WHAT IS NOT COVERED BY THE EMISSION WARRANTY

This warranty does not cover:

- 1 Malfunctions in any part caused by any of the following: misuse, abuse, improper adjustments unless performed by a VTNA dealer, modifications, alterations, tampering, disconnection, improper or inadequate maintenance, or use of fuels not recommended for the engine as described in the owner's manual.
- 2 Damage resulting from accident, acts of nature or other events beyond the control of VTNA.
- 3 The replacement of expendable maintenance items such as filters, hoses, belts, oil, thermostat and coolant made in connection with scheduled maintenance services once these parts have been replaced. Any parts replaced under warranty before the first required replacement point are warranted for the remainder of the warranty period.
- 4 Replacement items which are not genuine Volvo parts or not authorized by VTNA.
- 5 Loss of time, inconvenience, loss of use of vehicle or engine, or commercial loss.
- 6 Any vehicle on which the odometer or hourmeter has been disconnected or the mileage (or hours) has been altered so the actual usage cannot be readily determined.
- 7 Any vehicle registered and normally operated outside the United States.

## WHAT IS COVERED BY THE EMISSION WARRANTY

The following is a list of the items that are considered a part of the Emission Control Systems and are covered by the Emission Warranty when installed as original equipment by VTNA on vehicles which were built to conform to Environmental Protection Agency regulations.

**IMPORTANT** - This may not include expendable maintenance items. Emission related parts requiring scheduled maintenance are warranted until their first scheduled replacement point.

- I. Fuel Injection System
- II. Air Induction System
  - A. Intake Manifold
  - B. Turbocharge System
  - C. Charge Air Cooler (Intercooler)
- III. Exhaust Manifold
- IV. Miscellaneous Items Used in Above Systems
  - A. Hose, clamps, fittings and tubing
  - B. Pulleys, belts and idlers
  - C. Vacuum, temperature, and time sensitive valves and switches
  - D. Mounting hardware, sealing gaskets and PVC (if applicable)

<p style="text-align: center;"><b>THIS EMISSIONS PERFORMANCE WARRANTY STATEMENT IN NO WAY REPLACES, MODIFIES, ALTERS OR SUPERSEDES THE TRUCK WARRANTY CERTIFICATE, ITS TERMS AND CONDITIONS, AND ITS LIMITATIONS AND EXCLUSIONS.</b></p>
--

**BE CERTAIN YOU READ AND UNDERSTAND ALL WARRANTIES WHICH ACCOMPANIED YOUR VEHICLE.**

## 8 General Information

---

### Noise Emissions

Volvo Trucks North America, Inc. warrants to the first person who purchases this vehicle for purposes other than resale and to each subsequent purchaser, that this vehicle as manufactured by Volvo Trucks North America, Inc. was designed, built and equipped to conform, at the time it left the control of Volvo Trucks North America, Inc., with all applicable U.S. EPA Noise Control Regulations.

This warranty covers this vehicle as designed, built and equipped by Volvo Trucks North America, Inc., and is not limited to any particular part, component or system of the vehicle manufactured by Volvo Trucks North America, Inc. Defects in design, assembly or in any part, component or system of the vehicle as manufactured by Volvo Trucks North America, Inc., which, at the time it left the control of Volvo Trucks North America, Inc. caused noise emissions to exceed Federal standards, are covered by this warranty for the life of the vehicle.

## **Tampering with Noise Control System**

Federal law prohibits the following acts or the causing thereof:

(1) The removal or rendering inoperative by any person, other than for purposes of maintenance, repair, or replacement, of any device or element of design incorporated into any new vehicle for the purpose of noise control prior to its sale or delivery to the ultimate purchaser or while it is in use;

or

(2) the use of the vehicle after such device or element of design has been removed or rendered inoperative by any person.

Among those acts presumed to constitute tampering are the acts listed:

### **Noise Shields and Insulation**

Removing or rendering inoperative the engine and/or transmission noise deadening panels, shields or insulating materials.

Removing or rendering inoperative the cab-tunnel or hood noise insulating materials.

Removing or rendering inoperative any truck body mounted sound insulation components and/or shields (cab or fender shields, skirts, wheel housing splash shields, etc.).

### **Engine Control and Fuel Systems**

Removing or rendering inoperative, or modifying the engine control system (such as the ECU or the fuel system components) in order to allow the engine to operate outside of the manufacturer's specifications (e.g., exceeding the manufacturer's engine speed limits).

## 10 General Information

---

### **Cooling System**

Removing or rendering inoperative cooling system components (such as the temperature modulated fan clutch, fan shroud, fan ring, recirculation shields, etc.).

### **Exhaust System**

Removing or rendering inoperative exhaust system components (such as the muffler, pipes, clamps, etc.).

### **Air Intake System**

Removing or rendering inoperative air intake/induction system components (filter, filter housings, ducts, etc.).

## Noise Control System, Operator Inspection and Maintenance Requirements



### DANGER

Before inspecting a vehicle, set the parking brakes, place the transmission in neutral, and block the wheels. Failure to do so can result in unexpected vehicle movement and can cause serious personal injury or death.

A Noise Control System Maintenance Log is located in “Noise Control Log” page 16. This log should be used to document all Noise Control System related maintenance, whether the maintenance results from a specific noise control system inspection, or a deficiency identified during another general maintenance event.

If additional log space is needed, further entries may be added on a separate sheet of paper. Store these additions with the main log to preserve a comprehensive record. It is recommended that copies of all noise emissions related maintenance invoices be retained.

The following Noise Control System inspection and maintenance instructions contain suggested maintenance intervals. These intervals may need adjustment in order to best accommodate the specific vehicle usage. The following instructions only concern Noise Emissions related items and do not address or modify any general vehicle maintenance requirements.

## 12 General Information

---

### Exhaust System

Make sure the exhaust system is intact. Inspect for damage, misalignment and/or leakage. Primary system components requiring noise related inspection include muffler body, exhaust manifold, turbocharger, and all exhaust system (rigid and flexible) piping. Closely check the system for exhaust leaks. Special attention should be given to all welds, seams, gaskets, support points, clamps, couplings and connections.

Inspect all exhaust system fasteners, brackets, and clamps for damage and tightness. Check integrity of internal muffler baffling by revving the engine through normal operating speeds. Excessive rattling sounds or very loud operation indicates a failure within the muffler.

Repair or replace components as required. See Service Information in Group 177-500, Preventive Maintenance, Basic Service VN, VHD and Group 177-501 Preventive Maintenance, Annual Service VN, VHD for detailed repair and replacement procedures.

Inspection interval: Once every year.



#### **WARNING**

Hot engine! Keep yourself clear of all moving parts or hot engine parts, exhaust gases, and/or fluids. A hot engine, exhaust, and/or fluids can cause burns.



## **Air Intake/ Air Induction System**

Make sure the air intake system is intact. Inspect components for damage, misalignment and/or leakage. Primary system components requiring noise related inspection include the air cleaner housing, air cleaner element, turbocharger, charge air cooler and intake manifold.

Also inspect all ducts, pipes, hoses, tubing and elbows used to interconnect the system. Special attention should be given to all welds, seams, gaskets, support points, clamps, couplings and connections.

Inspect all intake system fasteners, brackets, and clamps for damage and tightness.

Repair or replace components as required. See Service Information in Group 177-500, Preventive Maintenance, Basic Service VN, VHD and Group 177-501 Preventive Maintenance, Annual Service VN, VHD for detailed repair and replacement procedures.

Inspection interval: Once every year.

## Cooling System



### **WARNING**

Do not work near the fan with the engine running or the ignition in the ON position. The engine fan can engage at any time without warning. Anyone near the fan when it turns on could be seriously injured.

Visually inspect cooling system components for damage, and/or misalignment.

Primary system components requiring noise related inspection include fan blades, fan clutch, fan shroud, fan ring, and recirculation shields. Check fan blades, fan ring, fan shroud, and recirculation shields for any damage. Verify that fan blades clear the fan ring. Inspect all related fasteners, brackets, and clamps for damage and tightness. Confirm operation of temperature modulated fan clutch.

Repair or replace components as required. See Service Information in Group 177-500, Preventive Maintenance, Basic Service VN, VHD and Group 177-501 Preventive Maintenance, Annual Service VN, VHD for detailed repair and replacement procedures.

Inspection interval: Once every year.

## **Sound Shielding and Insulation Devices**

Make sure sound shielding and insulating devices are intact. Inspect components for damage. Primary system components requiring noise related inspection include the hood, engine compartment insulating materials (including hood insulation, bulkhead insulation, doghouse insulation, etc.) splash shields, cab skirts, fender shields, and body panels. Inspect all related fasteners, brackets, and clamps for damage and tightness.

Repair or replace components as required. See Service Information in Group 177-500, Preventive Maintenance, Basic Service VN, VHD and Group 177-501 Preventive Maintenance, Annual Service VN, VHD for detailed repair and replacement procedures.

Inspection interval: Once every year.



## General

Three levels of the cab climate system are available. They can be identified by the appearance of the control panel.

The basic system is a heater and defroster unit only. The heater unit has a rating of at least 40,000 Btu.

The manually operated heating and air conditioning unit is controlled from the same panel as the heater system with the addition of a switch for turning the air conditioning system on (button with the snowflake symbol).

Another variant of the air conditioning system can be added as an option. This is called the Automatic Temperature Control (ATC) variant. It is identified with the label marked **ATC**. It allows all functions of the previous systems, plus the ability to maintain the temperature in the cab as set by the driver. The desired temperature is selected by the combination of the temperature control setting and the fan speed.

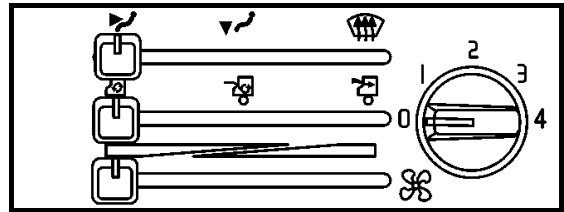

W8002961

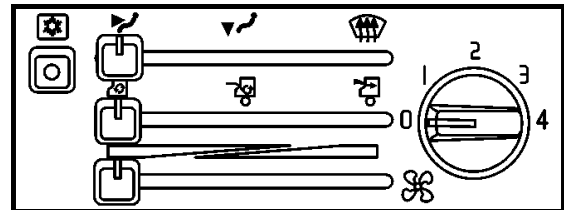

W8002962

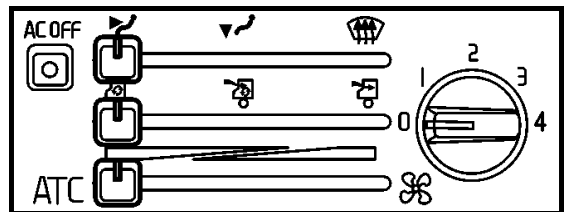

W8002938

## 18 Heating and Air Conditioning

---

The air conditioning only operates when the engine is running. Best performance from the air conditioning is achieved when all windows and vents are closed. At all times, make sure the cowl fresh air intake is free from snow, ice, leaves, etc.

**NOTE!** The air conditioning system is continuously monitored for correct function. The monitor module has a read-out for fault codes. See A/C Diagnostic Module in Group 04 “Operator’s Manual VNL and VNM” for more information.

**NOTE!** In the ATC model, the ATC controls the temperature in the cab by opening and closing a hot water valve and by cutting the AC compressor on and off. In order to lower compressor cycling and increase compressor life, the driver can press the AC OFF button, which prevents the AC compressor from activating and will only use the water valve to control the temperature in the cab.



### **DANGER**

Do not attempt to drive with the windshield covered by mist, fog or frost. The visibility is reduced which could lead to an accident causing severe personal injury or death. Read these instructions to be able to hold the windshield clear at all times. Maximum heat output for fast defrosting can only happen after the engine has reached operating temperature.

## Climate Unit Main Control Panel

### Fan Speed Control

The fan has four speeds, and an “OFF” or “0” position. When the fan control is in the 0 position, air flows out of the dash vents if the vehicle is moving at highway speeds and if the Fresh Air Control is set for outside air intake. If the Fresh Air Control is set for full recirculation, the fan has to be on for air to flow out the dash vents.

If equipped with air conditioning, the fan does not automatically change fan speed with changing temperatures. You must manually adjust the fan speed to the desired air flow.

Fan speed must be selected to meet either heating or cooling needs. For the heater only, settings of temperature and air flow must be adjusted as often as necessary to accommodate changing temperatures outside and inside the cab.

The ATC system is designed to maintain a constant temperature in the cab, which is set by the temperature control. As the system does not make automatic changes of fan speed, a selection of higher or lower fan speed may be needed to achieve the correct temperature.

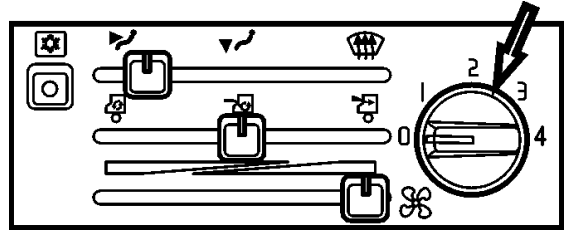

W8002983

## 20 Heating and Air Conditioning

---

### Air Distribution Control

The air distribution control is used to direct the air flow to either the dash vents, floor vents or defroster vents. The lever has detentes in the outer and middle positions so that it can be set without looking at the panel.

The air flow for the three major settings are described below. Any setting outside of the detented positions will be a mix of the air flows that depends on how far from the detented position the lever is.

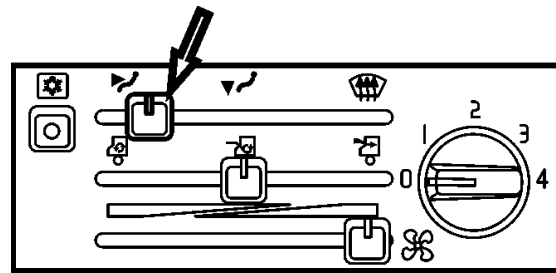

W8002984

With the control in the leftmost position, all air is directed out through the vents in the dash.

With the control in the middle position, most air is directed out through the floor vents and the cab door window vents. A small flow is directed out through the vents in the dash. This mix is approximately 80/20.

With the control in the rightmost position, most air is directed out through the front dash vents to the windshield and cab door windows. A small flow is directed out through the vents in the dash. This mix is approximately 70/30.

**NOTE!** When the air vents on the dash are open, some air always flow through them. To have maximum air flow to the floor or to the windshield and cab door windows, close the dash vents.



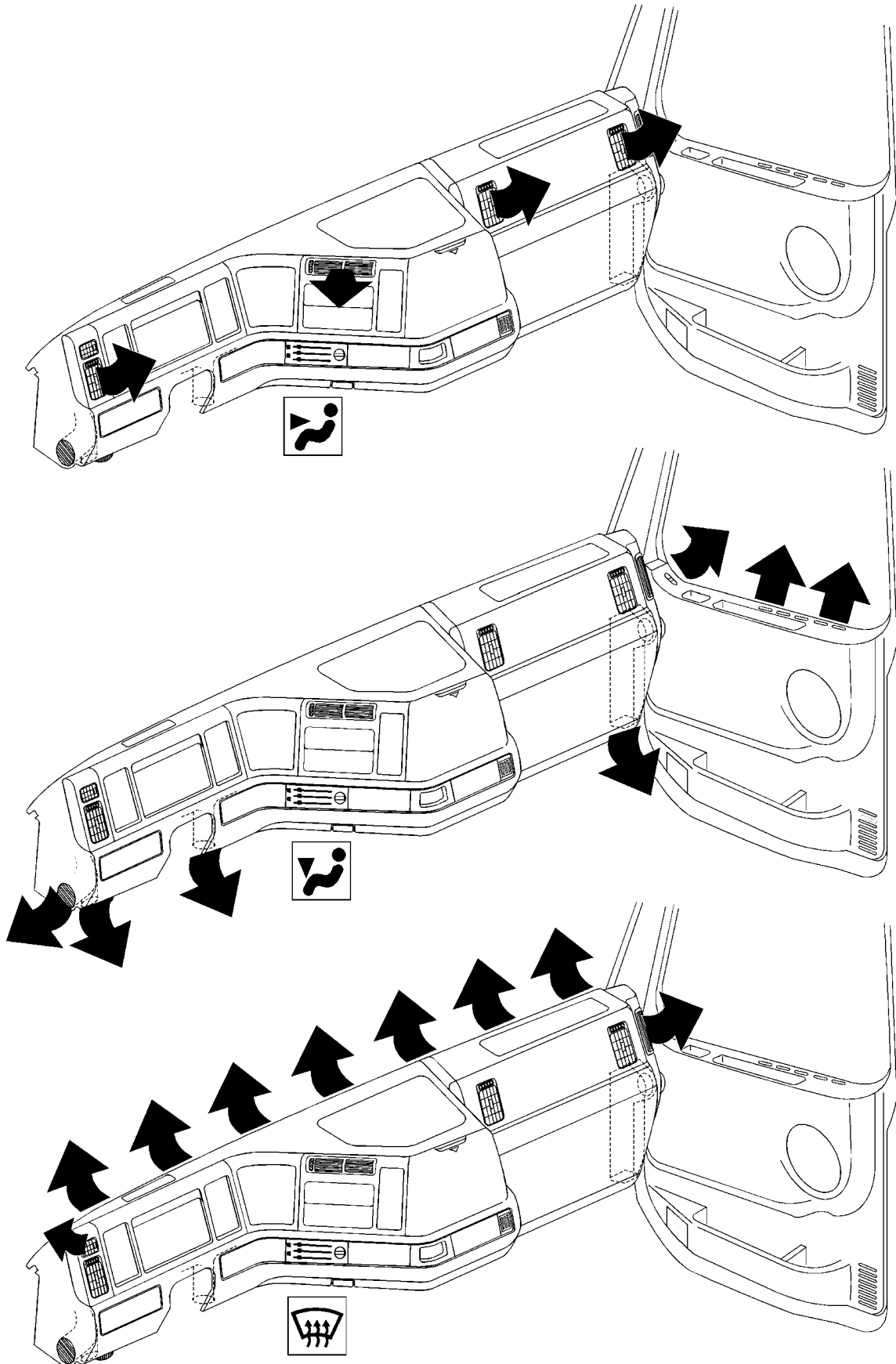

## 22 Heating and Air Conditioning

---

### Air Vents

- A Closed
- B Open
- C Lateral Air Flow
- D Vertical Air Flow

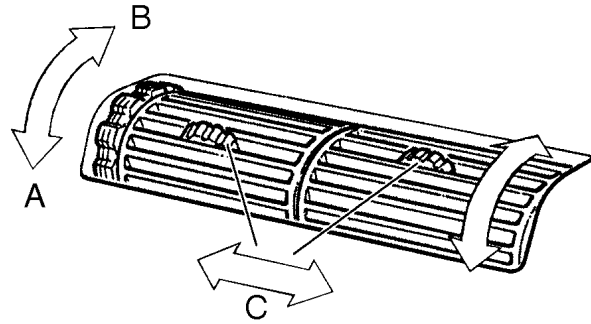

When heating the cab, all vents should be closed. However, the vents on the outer parts of the dash can be used for defrosting the cab door windows. When operating the air conditioning, all air vents should be completely open and the air flow directed upward.

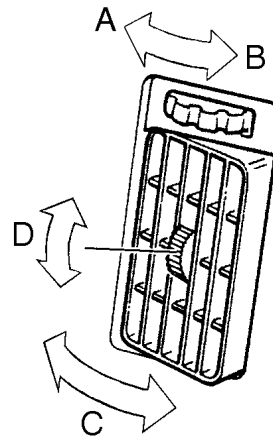

## Fresh Air Control

The middle slide lever is the Fresh Air/Recirculation Control. The settings can be anywhere from full fresh air intake to only recirculated air. Settings can be chosen anywhere in between to give the desired flow of air.

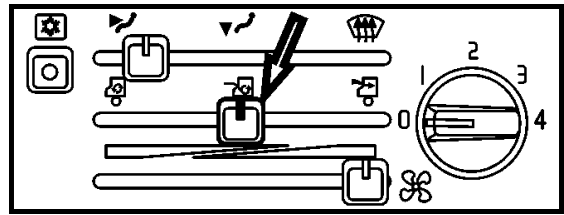

W8002985

In the leftmost position, the fresh air inlet is closed. All air is recirculated within the cab. It can be used to heat up or cool down the cab temperature quickly or to close the intake from letting in odors, etc. with the intake air.

In the middle position, there will be a 20% addition of fresh air to the 80% of recirculated air. This position is well suited for use when the air conditioning is engaged so a minimum of warm or cooled air is lost through the evacuation vents, while fresh air is still added to the cab.

In the rightmost position, the fresh air inlet is completely open. This is best used when heat is required (wintertime) and when defrosting or de-icing.

## 24 Heating and Air Conditioning

---

### Temperature Control

The bottom slide lever is the Temperature Control, which operates the coolant control valve. In the extreme left position the flow of coolant is shut off by the control valve, which means no heat from the climate unit. The heat will increase the further to the right the control is moved.

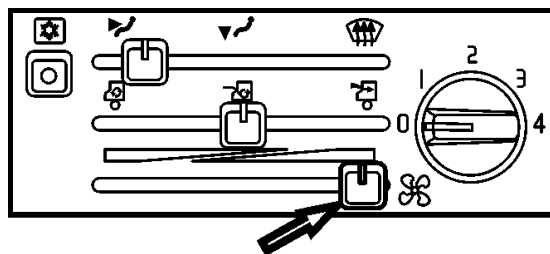

W8002986

The temperature control should be used as a thermostat, together with the fan speed, to “dial” in the desired temperature when using the air conditioning. The desired temperature is selected by the combination of the temperature control setting and the fan speed. The ATC allows the temperature to be automatically maintained to any regulated settings.

Using the heater on days when the outside temperature is low but there is direct sunlight heating through the windows, the air distribution control should be set in the center position (air directed to the floor) and the air vents open, and at the same time, the temperature control should be set around the middle position. Warm air is then distributed so that it is warmest at the floor and cooler air is distributed via the air vents on the dash.

When the temperature control is set in one of the end positions, the temperature at the floor vents and the air vents is the same.

## AC Manual Control

When the vehicle is equipped with air conditioning, the control panel has a button for engaging the air conditioning compressor. This button is marked with a snowflake symbol. To engage the AC push the snowflake button.

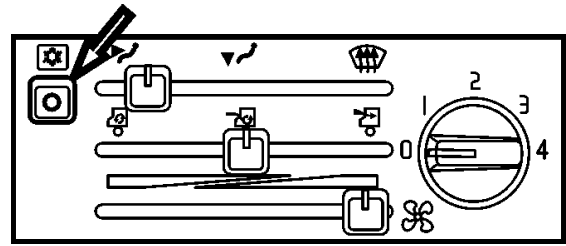

W8002987

When the air conditioning button is pressed, the fan speed control must be set on 1 through 4 for the air conditioning to start. If the air conditioning button is pressed when the fan speed control is set on 0, the air conditioning will not start.

To set the air conditioning temperature, adjust the temperature control and fan speed until the desired temperature/air flow has been reached.

## Automatic Temperature Control (ATC) Overview

The Automatic Temperature Control (ATC) is identified with the lettering “ATC” at the left bottom corner of the air conditioning panel. The ATC is automatically activated when the truck engine is started. The desired temperature in the truck can be regulated by the combination of temperature control setting and the fan speed. Therefore, by adjusting the temperature settings and the fan speed, the driver can increase or decrease the temperature in the cab.

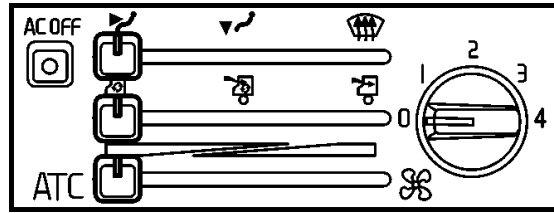

W8002938

The ATC air conditioning works with the coolant control valve as a “thermostat,” making automatic adjustments with input from sensors for air output and for air inside of the cab. However, the fan speed may also have to be adjusted, increasing or decreasing air flow, to achieve correct cab temperature.

To set a new desired temperature, simply slide the temperature control lever to a higher or lower setting and the system will maintain the new temperature within the ability of the temperature control.

- 1 **AC OFF** button: Turns off the air conditioning.
- 2 Air distribution slide lever.
- 3 Fresh air slide lever.
- 4 Temperature slide lever.
- 5 Fan speed knob.

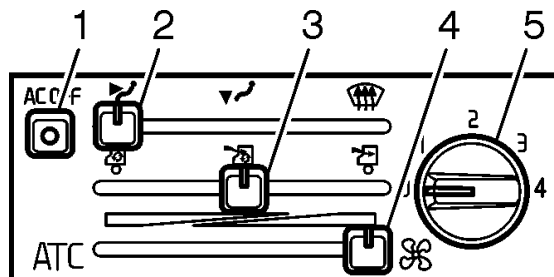

W8002940

## Mist and Ice Removal

- 1 Make sure **AC OFF** is **NOT** depressed.
- 2 Set air distribution slide lever to extreme right of the AC panel (air blows onto the windows from the outlets.)
- 3 Set the fresh air slide lever to the extreme right of the AC panel (position for fresh air only).
- 4 Set the temperature slide lever to the extreme right of the AC panel (maximum heat.)
- 5 Turn the fan speed knob to position 4.

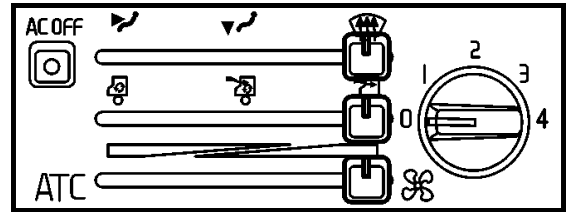

W8002941

## Setting Temperature Controls

- 1 Make sure **AC OFF** is **NOT** depressed.
- 2 Set the temperature slide lever to the desired position.
- 3 Turn the fan speed knob to positions 1, 2, 3 or 4.

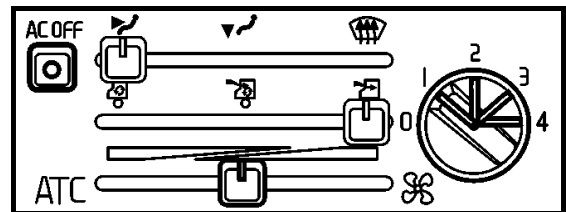

W8002942

## Cold Temperature Setting

- 1 Make sure **AC OFF** is **NOT** depressed
- 2 Set air distribution slide lever to the extreme left of the AC panel.
- 3 Set the fresh air slide lever to the extreme right of the AC panel (position for fresh air only.)
- 4 Set the temperature slide lever to the extreme left of the AC panel (maximum cool air.)
- 5 Turn the fan speed knob to positions 1, 2, 3 or 4.

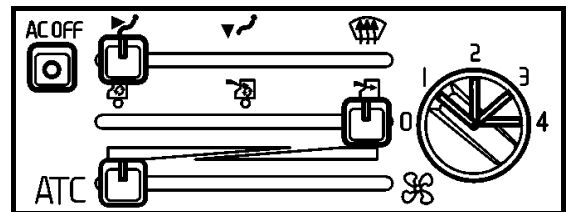

W8002943

## 28 Heating and Air Conditioning

### Warm Temperature Setting

- 1 Set air distribution slide lever to the middle of the AC panel.
- 2 Set the fresh air lever to the extreme right of the AC panel (position for fresh air only.)
- 3 Set the temperature slide lever to the extreme right of the AC panel (maximum heat.)
- 4 Turn the fan speed knob to positions 1, 2, 3 or 4.

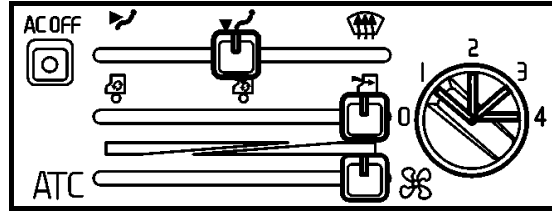

W8002944

Best performance from the air conditioning is achieved when all windows and vents are closed. At all times, make sure the cowl fresh air intake is free from snow, ice, leaves, etc.

**NOTE!** The ATC controls the temperature in the cab by opening and closing a hot water valve and by cutting the AC compressor on and off.

In order to lower compressor cycling and increase compressor life, the driver can press the AC OFF button, which prevents the AC compressor from activating and will only use the water valve to control the temperature in the cab.

**NOTE!** The air conditioning system is continuously monitored for correct function. The monitor module has a read-out for fault codes. See A/C Diagnostic Module in Group 04 “Operator’s Manual VNL and VNM” for more information.



**DANGER**

Do not attempt to drive with the windshield covered by mist, fog or frost. The visibility is reduced which could lead to an accident causing severe personal injury or death. Read these instructions to be able to hold the windshield clear at all times. Maximum heat output for fast defrosting can only happen after the engine has reached operating temperature.



## Cab Ventilation

### Ventilation Guidelines

If at any time there is any doubt that exhaust fumes are entering the cab, have the cause of the fumes determined and corrected as soon as possible. If the vehicle must be driven under these conditions, drive only with all windows open.

Protect against carbon monoxide entry into the cab. Keep the engine exhaust system, cab and cab ventilation system properly maintained. It is recommended that the exhaust system and cab are inspected by a competent technician:

- At every engine oil change.
- Whenever a change is noticed in the sound of the exhaust system.
- Whenever the exhaust system, underbody or cab is damaged.

To allow for proper operation of the vehicle ventilation system, keep the inlet grille at the base of the windshield clear of snow, ice, leaves and other obstructions at all times.

Do not park the vehicle and let the engine run or idle for more than 10 minutes with the ventilation system control switch in the *off* position. Even with the ventilation system on, running the engine while parked or stopped for long periods of time is not recommended.



**DANGER**

Do not breathe the engine exhaust gas. It contains carbon monoxide, which has no color or odor. Carbon monoxide is a dangerous gas which can cause unconsciousness or death.



**DANGER**

Diesel engine exhaust and some of its constituents are known to the state of California to cause cancer, birth defects or other reproductive harm.

## 30 Heating and Air Conditioning

---

Entry of carbon monoxide into the cab is possible with a poorly repaired, damaged or corroded exhaust system or cab. Do not run the engine in confined areas, such as garages or next to a building, any more than necessary. The area must be properly ventilated when the vehicle is stopped with the engine running for more than a few minutes:

- Adjust the heating or cooling system to force outside air into the cab. Do this by setting the fan to medium or high speed and with the controls set in any position except for recirculation of air inside of the cab.
- Keep the exhaust pipe area clear to help reduce the buildup of exhaust gas under the vehicle.

### Cab Air Filter

Air going into the cab passes a filter located on the right, front side of the cab. Remove the filter and clean with an air gun (no more than 20 psi pressure) after 40,000 miles (64,000 km), (in dusty conditions as often as every 10,000 miles [16,000 km]). Make sure the air stream is directed from the inside out.

The filter should not be cleaned and reused more than once. Replace with a new filter after maximum 70,000 miles (110,000 km), or earlier if driving in dusty conditions. A clogged filter decreases the efficiency of the air conditioning system.

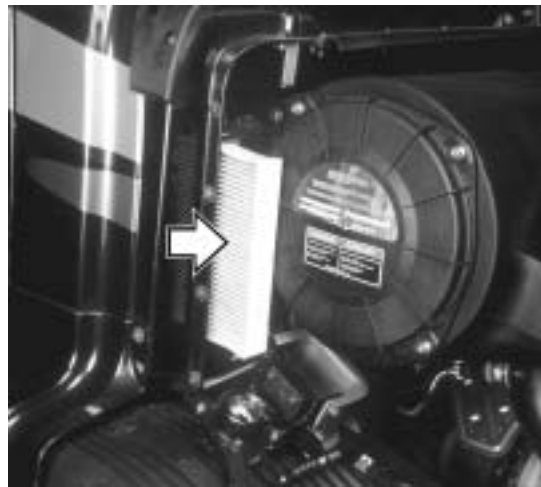

W8002474

## Parking Brake Alarm

The Parking Brake Alarm is an audible warning signal that alerts the driver about problems affecting the parking brake as described below.

The most effective way to observe or check for the first warning signal is to listen to the truck when it is in "ignition mode" (key in ignition and turned to ON position without starting the engine).

### Audible Warnings:

Ignition mode Warning

Running mode/Alarm Warning

### Ignition mode Warning

1. Place key in ignition, turn key to the ON position without starting the engine. Is an audible signal heard? If Yes, this indicates proper connection and no action is needed on the driver's part.

The "ignition on" warning signal is a short audible signal with three quick bell-like tones, which is heard two seconds after the key is turned/cycled to the ON position.

2. If no audible signal is heard the ignition signal is NOT ON. Take the vehicle to your Volvo dealer.

**NOTE!** It is important that the driver be aware of this mandatory audible signal.

3. Place key in ignition, turn key to the ON position without starting the engine. Is a second warning signal heard? Is the Park brake applied? If No, apply Park brake, check bulb in the dash, the bulb should be lit. Turn or cycle the key to the ignition ON position. Is the ignition on signal on? If Yes, this is ok and no action is needed on the driver's part.

**NOTE!** If more than one signal is heard see your Volvo dealer.

### Running mode Warning

Immediately after the ignition mode runs, the module changes to running mode. The running mode module reads road speed of at least 6 km/h (4 MPH) and above. Above road speed of 6 km/h (4 MPH) it checks/monitors the park brake status. If road speed is more than 6 km/h (4 MPH) and the park brake is applied, the module goes into alarm mode.

### Alarm Warning

1. The alarm warning is a series of bell-like tones that sound faster and higher pitched than the "ignition on" signal.
2. As described in the Running mode, if the park brake is applied and road speed is 6 km/ (4 MPH) or more, the alarm warning signal comes on and **remains on** until appropriate action is taken: the parking brake must be released or speed reduced.



#### **WARNING**

Driving with the parking brake applied will cause brakes to overheat. This may lead to wheel end fire.

To avoid overheating make sure the parking brake knob is pushed in before driving off. If the trailer is coupled to the tractor make sure both parking brake knobs are pushed in.

## Adjustable Steering Column (option)

The steering column is fixed as standard. An adjustable steering column is available as an option. The adjustment device is operated by a pedal on the left side of the floor. To make adjustments, press the pedal down and move the steering column to the desired position, then release the pedal.



W6000876



### **DANGER**

Do not adjust the steering wheel while the vehicle is moving. Never operate the vehicle with the steering wheel adjusted to its uppermost position (exiting cab position). Make all adjustments before starting the vehicle, to prevent loss of vehicle control, which can cause personal injury or death.

# **VOLVO**

Volvo Trucks North America, Inc.

P.O. Box 26115, Greensboro, NC 27402-6115

Volvo Trucks Canada, Ltd.

6490 Vipond Drive, Mississauga, Ontario L5T 1W8

<http://www.volvotrucks.volvo.com>

©Volvo Trucks North America, Inc., 2002

PV776-20 169629  
Publication Date - 2.2002